

COREFLEX®

WELDABLE THERMOPLASTIC WATERPROOFING WITH ACTIVE POLYMER CORE FOR CAST-IN-PLACE CONCRETE AND SHOTCRETE APPLICATIONS



COREFLEX®

THERMOPLASTIC WATERPROOFING WITH AN ACTIVE LAYER

CONTENTS

LIMITATIONS

PRODUCT DESCRIPTION

TYPICAL PERFORMANCE AND PHYSICAL PROPERTIES

ACCESSORIES

ASSOCIATED PRODUCTS

INSTALLATION GUIDELINES

SECTION 1: MEMBRANE WELDING PROCEDURES AND EQUIPMENT

- 1.1 General Membrane Orientation & Overlaps
- 1.2 Hand Welding
- 1.3 Manual Welding Equipment
- 1.4 Machine Welding
- 1.5 Quality Control/Inspection of Welded Seams
- 1.6 Installation

SECTION 2: DETAILING

- 2.1 Large Penetrations
- 2.2 Round Penetrations: 75–100 mm (3"–4")
- 2.3 Round Penetrations: 50 mm (2") or smaller
- 2.4 Square/Rectangular Penetrations
- 2.5 Butt-Joint Detailing
- 2.6 Ground Level Termination
- 2.7 Property Line Shoring Wall to Slab Transition
- 2.8 Back Filled Wall – Edge of Slab

SECTION 3: UNDERSLAB INSTALLATION METHODS

- 3.1 General
- 3.2 Substrate Preparation
- 3.3 Grade Beams, Footings & Elevator Pits
- 3.4 Pile Caps

SECTION 4: PROPERTY LINE CONSTRUCTION

- 4.1 General
- 4.2 Shoring Wall Preparations
- 4.3 Property Line Wall Installation
- 4.4 Rebar Supports
- 4.5 Tie-Backs

SECTION 5: BACKFILLED WALLS

- 5.1 Surface Preparation
- 5.2 Installation

SECTION 6: SPECIAL CONDITIONS

- 6.1 Precast Concrete Construction
- 6.2 Contaminated Conditions
- 6.3 Hydrostatic/Non-Hydrostatic Conditions
- 6.4 Expansion Joints
- 6.5 Miscellaneous
- 6.6 Important Notice

THIS MANUAL CONTAINS THE INSTALLATION GUIDELINES FOR THE COREFLEX 60 AND COREFLEX XP WATERPROOFING SYSTEMS FOR BOTH CAST-IN-PLACE CONCRETE AND SHOTCRETE APPLICATIONS, INCLUDING UNDERSLAB, PROPERTY LINE WALLS, BACKFILLED FOUNDATION WALLS, AND TUNNELS. FOR APPLICATIONS NOT COVERED IN THIS MANUAL, CONTACT CETCO FOR SPECIFIC INSTALLATION GUIDELINES. BEFORE INSTALLATION, READ THIS MANUAL TO GAIN FAMILIARITY WITH SPECIFIC PROCEDURES AND APPLICATIONS.

PLEASE NOTE: ALL REFERENCES TO "COREFLEX", APPLY TO BOTH THE COREFLEX 60 AND THE COREFLEX XP WATERPROOFING SYSTEMS. ALL REFERENCES TO "WATERSTOP-RX/XP" APPLY TO WATERSTOP-RX OR WATERSTOP XP.

LIMITATIONS

COREFLEX is designed for waterproofing applications where the product is properly covered and confined. COREFLEX should only be installed after substrate preparation has been properly completed and is suitable to receive the waterproofing system. COREFLEX should be used with structural grade reinforced cast-in-place concrete with conventional forms that produce a smooth surface. Use COREFLEX with reinforced shotcrete walls conforming to ACI 506 Core Grade 1 or 2; minimum 200 mm (8") thick, applied from the bottom up in their full wall structural design thickness in a single application per shotcrete lift. Consult CETCO for guidelines for stay-in-place concrete forms.

COREFLEX should not be installed in standing water or over ice. Site groundwater samples should be submitted to CETCO for compatibility testing. COREFLEX is designed for use under reinforced concrete slabs 150 mm (6") thick or greater with a mud slab substrate. COREFLEX is capable of bridging typical shrinkage cracks in concrete up to 1.5 mm (1/16").

COREFLEX membranes are not designed to waterproof expansion joints. Consult with CETCO regarding all expansion joint applications and limitations.

PRODUCTION DESCRIPTION

COREFLEX 60

A dual component waterproofing membrane system that combines a modified PVC reinforced thermoplastic membrane with an Active Polymer Core (APC) layer into one high performance, easy to use product. This composite membrane provides both a fully welded thermoplastic membrane with an integrally bonded self-sealing active waterproofing layer to assure optimal performance. No other product fits the range of installation conditions that COREFLEX does; including underslab, property line walls, backfilled foundation walls, tunnels, earth covered structures, new and restoration plaza decks, split-slab construction and greenroofs.

COREFLEX XP

A dual-component waterproofing membrane system that combines a modified PVC reinforced thermoplastic membrane with an XP technology core layer in to one high performance, easy to use product. COREFLEX XP offers the same installation and performance benefits as COREFLEX 60, but features XP technology, the latest innovation in active waterproofing. This advanced polymer technology provides exceptional performance in a wide range of ground contaminants, including high-salinity conditions. **COREFLEX XP should be used with other XP detailing products: CORETEX XP, SEAL-X XP, and WATERSTOP XP.**

ACCESSORIES

ADHESIVE SB-100: Adhesive for securing CoreFlash membranes to various substrates, including cured concrete, wood, metal and cementitious boards.

AKWASWELL®: Hydrophilic polyurethane caulk used for detail work including pipe penetrations.

CETSEAL®: A multipurpose UV stable single component polyether moisture cure sealant/adhesive. Primary applications are grade termination sealant, membrane lap sealant and waterstop adhesive.

CORECAP® TIE-BACK COVERS: Preformed non-reinforced thermoplastic flashings, designed to provide a welded thermoplastic cover over tie-back heads on property line shoring walls; three preformed sizes available. CoreCap(s) used in conjunction with same size rigid TB-Boot.

CORECLAD®: 24 ga. stainless steel sheet laminated on one side with thermoplastic polymeric coating for flashing applications and termination details.

COREDISC®: CoreDisc is a nominal 100 mm (4") round x 1.5 mm (60 mil) non-reinforced thermoplastic disc. CoreDiscs are used for T-joint patches and to repair small punctures in the PVC membrane.

COREFLASH: 1.5 mm (60 mil) thick reinforced thermoplastic membrane (yellow top coat and black bottom coat) used for non-exposed detail and flashing applications including curbs, walls, field wraps, butt-joints and patches.

COREFLASH NR: 1.5 mm (60 mil) thick UV stable non-reinforced extruded white thermoplastic membrane used for detail and flashing applications including curbs, walls, field wraps and patches.

COREFLASH UV: 1.5 mm (60 mil) thick UV stable reinforced thermoplastic membrane (white top coat and black bottom coat) used for flashing applications exposed to direct UV and or weathering conditions including curbs, walls, field wraps and patches

CORETEX®: APC polymer impregnated geotextile for transition details, corners, butt-joints and protection from rough edges and surfaces.

CORETEX XP®: Used with COREFLEX XP, CORETEX XP is a polymer impregnated geotextile featuring XP technology for transition details, corners, butt-joints and protection from rough edges and surfaces. Herein referred to in this manual as CORETEX.

INDUCTION WELDING PLATE: 80 mm (3 1/4") diameter nominal metal plate with thermoplastic coating for attachment of COREFLEX membrane to shoring with induction welding machine.

PF-150: Molded non-reinforced thermoplastic flashings, specially designed for round penetrations 50 mm (2") or less in diameter.

PF-340: Pre-fabricated factory welded thermoplastic pipe penetration sleeve with open cut side for simple installation around 75 mm (3") to 100 mm (4") pipe penetrations; comprised of a non-reinforced 60 mil membrane stack and a 60 mil reinforced membrane base flange.

SEAL-X XP: SEAL-X XP is trowel-grade detailing mastic designed for a variety of surface preparation and detailing work. It swells upon contact with water to form a watertight barrier, even in high-saline water conditions.

TW-ANCHOR: Specially designed anchors that allow for rebar to be tied into and supported without creating membrane penetrations.

UNIVERSAL CORNER: Molded non-reinforced thermoplastic flashings used to seal inside and outside corner details. Universal Corners come as one piece and are trimmed to fit the appropriate corner condition.

ASSOCIATED PRODUCTS

AQUADRAIN®: Foundation drainage composite consisting of a molded profile core and a filter fabric. System includes sheet drainage and base drain collection. CXJ-200/CXJ-400 EXPANSION JOINTS: Extruded thermoplastic dual-cell center gland expansion joint with integrated side flashings that are welded to the COREFLEX membrane for sealing expansion joints in below grade applications. Available in 50 mm (2") and 100 mm (4") wide joint glands.

WATERSTOP-RX®: Hydrophilic, swelling concrete joint waterstop used around penetrations and applicable concrete joints. WATERSTOP-RX swells upon hydration to form a positive seal in concrete cold pour joints.

WATERSTOP® XP: Featuring XP technology, WATERSTOP XP is proven effective in a wide range of environments including high-saline conditions. Effective for both horizontal and vertical joints, it expands upon contact with water to form a positive seal to stop water ingress through cast-in-place concrete construction joints and around pipe penetrations.

COREFLEX®

THERMOPLASTIC WATERPROOFING WITH AN ACTIVE LAYER

SECTION 1 MEMBRANE WELDING PROCEDURES & EQUIPMENT

1.1 GENERAL MEMBRANE ORIENTATION AND OVERLAPS

All COREFLEX membrane overlaps require that both the thermoplastic membrane and the APC/XP layers (active layers) overlap a minimum 100 mm (4") with all thermoplastic membrane edges continuously welded per CETCO guidelines.

Membrane overlaps shall be oriented to shed water (shingle style) wherever possible. Specific equipment, especially wedge welders, may require greater overlap dimensions to facilitate welding.

Welding equipment shall be approved by CETCO. Contact your local CETCO representative for an updated list of suitable welding equipment. CETCO recommends that the installer tests all new welding equipment with COREFLEX prior to purchase or prior to using it at the project site.

All welding shall be performed by CETCO Approved Applicator staff that have successfully completed a two day course of instruction provided by CETCO prior to project work. Successful course participants are provided a CETCO COREFLEX Certified Welder ID Card that is required to be in their possession on site while welding. For information on CETCO's COREFLEX Training Class, contact your local CETCO representative.

The use of automated welding equipment is recommended for all COREFLEX and CoreFlash membrane overlap seams exceeding 3 m (10') in length.

All thermoplastic welds shall be continuous and without interruption or defect.

Along the long roll edges, COREFLEX is produced with the active layer offset 150 mm (6") from the PVC membrane layer to facilitate thermoplastic welding. Overlap the adjacent membrane edges, PVC to PVC, and maintain a uniform minimum overlap width of 100 mm (4") for both the PVC layer and the active layer. Dependent on the membrane orientation for an application, COREFLEX may be welded with either the yellow thermoplastic side or the active layer side oriented toward the installer. In all applications the thermoplastic side shall be oriented outward, relative to the interior of the structure.

When welding with the active layer side up, it will be necessary to fold the Active layer selvage edge back so that it is out of the way prior to running the welding equipment. Depending on the angle of the tip assembly, some welding equipment may scorch the edge of the folded

active layer. In this orientation adjust the equipment so that the tip assembly is positioned slightly shallower in the overlap to avoid scorching the folded active layer.

In an application with the active layer side up, once the thermoplastic welding process is complete, fold back the active layer selvage edge to its original position, whereas it overlaps the adjacent membrane active layer a minimum 100 mm (4"). Adhere the overlapped active layer selvage edge in place with dabs of CETSEAL maximum 300 mm (12") on center or a continuous bead of CETSEAL within the active layer overlap.

To facilitate thermoplastic welding along roll butt end edges or field cut roll dimensions where the active layer and PVC are trimmed flush at the edge, cut the ends straight and at a right angle to a long roll edge.

Place the butt ends (or field cut dimensions) of adjacent rolls aligned 25 mm (1") of each other to accommodate a single welding pass. Best practice is to trim adjacent roll ends to form a common edge alignment. Sequencing of the welding and placement of the Coretex strip will depend on the orientation of the COREFLEX membrane. Both the PVC membrane and active layer will need to be spliced. Cut strips, a minimum of 225 mm (9") of CoreFlash and Coretex respectively.

When working with the active layer side up, the welding of the CoreFlash strip is typically carried out first (maintaining a minimum 100 mm (4") overlap) followed by the placement of the Coretex strip. Overlap the COREFLEX 100 mm (4") onto the CoreFlash strip at the butt ends of the rolls and create a continuous thermoplastic weld between the CoreFlash strip and the COREFLEX membrane. Repeat on the other side of the butt end or cut edge. Once welds are completed and verified on both edges place the 225 mm (9") Coretex strip, centered, over the welded butt end splice and secure with dabs of CETSEAL maximum 300 mm (12") on center or a continuous bead of CETSEAL.

When working with PVC thermoplastic side up, the 225 mm (9") Coretex strip must be placed first with each adjacent COREFLEX edge overlapping the Coretex strip a minimum 100 mm (4"). In this instance it is not required to secure the Coretex strip with CETSEAL as the weight of the membrane will keep the Coretex strip in place.

Depending on site and detail specific conditions, alternate membrane overlap/weld methods may be required or desired. Consult CETCO for alternate membrane installation techniques, procedures, and details to properly provide a 100 mm (4") membrane overlap with a continuous thermoplastic weld. Strictly adhere to CETCO's membrane welding guidelines. All welds shall be continuous and without interruption or defect. All surfaces to be welded shall be clean and dry. No adhesives shall be present within the areas of the weld. Do not use chemical cleaners to remove dirt and debris. Use cotton rags to clean membrane; do not use synthetic rags.

1.2 HAND WELDING

1.2.1 APPROPRIATE HOT-AIR HAND WELDER TEMPERATURE CALIBRATION

COREFLEX, CoreFlash and CoreFlash NR all require different temperature settings in order to weld the products efficiently. Other factors that can have an affect on temperature setting include, but are not limited to, power, ambient temperature, membrane storage and weather. In order to ensure that the hot-air hand welder is set to the correct temperature, each type of membrane shall be tested prior to installing field material for that day.

COREFLEX: COREFLEX is a composite membrane consisting of an active layer and PVC layer rather than COREFLASH, which is just a PVC membrane. Due to the inclusion of the active layer, the welding process will be slower than welding COREFLASH and the temperature setting of the hot-air hand welder will need to be set lower. Set the hot-air hand welder to a setting of approximately 400° C (750° F) If using an analog model consult hot-air welder manufacture as to which temperature setting corresponds to 400° C (750° F). Using a scrap piece of COREFLEX, approximately 100 mm (4") x 100 mm (4"), hold the nozzle tip of the hot-air hand welder 12 mm (1/2") from the membrane face for a period of 8–10 seconds. At the end of the 8–10 seconds, remove the heat source and immediately press the handle edge of the silicon roller into the heated area and attempt to displace the heated PVC creating a visible displacement (smear) in the top surface of the PVC. This visible displacement of PVC confirms that the temperature of the hot-air hand welder is sufficient for welding the membrane together. There should be little to no discoloration of the membrane. If brown to black discoloration is present after removing the heat source, the temperature is too high and can cause burning of the membrane within the overlap when completing the welding process. If there is no visible displacement (smear) of the PVC membrane surface with the handle edge of the silicon roller after 8 – 10 seconds, then the temperature is too low. Increase or decrease the temperature of the hot-air hand welder until an appropriate temperature setting is reached.

COREFLASH: Set the hot-air hand welder to a setting of approximately 427° C (800° F). If using an analog model consult hot-air welder manufacturer as to which temperature setting corresponds to 427° C (800° F). Using a scrap piece of CoreFlash approximately 100 mm (4") x 100 mm (4"), hold the nozzle tip of the hot-air hand welder 13 mm (1/2") from the membrane face for a period of approximately 5 seconds. At the end of the 5 seconds, remove the heat source, using the handle edge of the silicon roller immediately press into the heated area and attempt to displace or smear the molten PVC creating a visible displacement. This movement of PVC membrane allows the user to confirm that the temperature of the hot-air hand welder is sufficient for welding the membrane together. Upon removing the heat after 5 seconds there should be little to no discoloration of the membrane. If brown to black discoloration is present after removing the heat source, the temperature is too high and can cause burning of the membrane within the overlap when conducting the welding process. Should there be no movement of the PVC membrane with the handle edge of the silicon roller after 5 seconds then the temperature is too low. Increase or decrease the temperature of the hot-air hand welder until an appropriate temperature setting is reached.

COREFLASH NR: CoreFlash NR is a non-reinforced membrane. This membrane can be welded at a lower temperature setting than both COREFLEX and CoreFlash, therefore a lower temperature should be utilized for CoreFlash NR. Set the hot-air hand welder to a setting of approximately 343° C (650° F). If using an analog model consult hot-air welder manufacture as to which temperature setting corresponds to 343° C (650° F). Using a gloved hand and a scrap piece of CoreFLASH NR, approximately 100 mm (4") x 100 mm (4"), quickly fold this scrap piece in half over the nozzle tip of the hot-air hand welder, pinch the membrane against either side of the nozzle tip and draw the piece of CoreFlash NR down the tip. This should transfer a white coating of PVC on the front and back flat areas of the nozzle tip. The PVC coating on the nozzle tip should maintain a white appearance for approximately 30 seconds. If the coating turns brown or burns within the 30 second period, the temperature is too high; decrease the temperature setting on the hot-air welder and retest. The 30-second period will allow for the scrap piece of CoreFlash NR to cool as well. Once the CoreFlash NR is cool, attempt to pull the welded sample apart; the membrane should tear around the welded area rather than separate at the weld. If the weld is pulled apart increase the temperature of the hot-air hand welder and retest.

1.2.2 HAND WELDING PROCESS

Once the temperature setting has been accurately tested, welding membrane overlap seams with a hot-air hand welder shall be completed per the following three step process:

STEP 1. TACK WELD



STEP 1. Tack Welding

Overlap the COREFLEX membrane ensuring that the PVC selvage edge is overlapping the adjacent sheets' PVC layer a minimum of 100 mm (4"). Tack weld the overlap to hold both thermoplastic membranes together to maintain the minimum 100 mm (4") wide overlap by inserting the nozzle tip of the hand welder into the overlap seam approximately 50 mm – 75 mm (2"–3") depth. Apply pressure with 1 or 2 fingers over the nozzle tip, when you feel warmth telegraphing through the membrane pull out the nozzle and press firmly down on the membrane to set the tack weld. Repeat this tack weld process intermittently along the membrane overlap while maintaining the minimum 100 mm (4") overlap.

COREFLEX® THERMOPLASTIC WATERPROOFING WITH AN ACTIVE LAYER

STEP 2. PRE-WELD



STEP 2. Pre Weld Placement

Insert the nozzle tip into the membrane overlap seam approximately 40 mm (1-1/2") with the nozzle tip parallel to the sheet edge. Using a silicon roller, press both membranes together at the end of the membrane overlap to trap the hot-air and seal off the start of the pre-weld. Then using the crease in the nozzle as a depth guide, create a thin, continuous pre-weld approximately 25 mm (1") inside the membrane overlap seam. Form a continuous thin pre-weld by moving the hand held hot-air welder while simultaneously pressing both membranes together just in front of the hot-air welding tip with the silicon roller for the length of the weld. The pre-weld will prevent the loss of hot-air and concentrate heat along the seam edge of the overlap during the final weld.

STEP 3. FINAL WELD



STEP 3. Final Weld Placement

Insert the nozzle tip of the hand welder into the membrane overlap seam at a 45° angle relative to the membrane edge.

When welding COREFLEX/CoreFlash (overlying layer) to COREFLEX (underlying layer) with the yellow PVC membrane side up (facing the installer) the hot-air hand welder should be held up at a 45° angle to the membrane, directing more heat to the underlying membrane to properly heat the underlying COREFLEX to a temperature sufficient to form a thermoplastic weld.

When welding COREFLEX (overlying layer) to COREFLEX/CoreFlash (underlying layer) with the active layer side up (facing the installer)

hot-air hand welder should be held at the lowest angle possible, directing heat to the top membrane to properly heat the top COREFLEX-60 membrane to a temperature sufficient to form a thermoplastic weld.

With either of the above welding orientation conditions, once the proper welding temperature has been reached and the thermoplastic membrane surface begins to "flow", apply light pressure with a hand roller, by rolling across the overlap seam with the hand roller running parallel to the nozzle tip (at an approximate 45° angle across the membrane overlap). As rolled, a small bead of molten material should extrude out of the seam edge.

When welding transitions from one plane to another (as in the horizontal to vertical plane change from slab to wall applications) begin the weld at the corner transition then work outward on both surfaces. Weld a COREDISC or COREFLASH NR patch over the seam at the transition.

STEP 4. WELD WIDTH VERIFICATION



STEP 4. Weld width verification

Verify the weld width: Refer to Section 1.5 for weld testing procedures.

1.3 MANUAL WELDING EQUIPMENT

HAND HELD HOT-AIR WELDERS

For all straight field seams use a 40 mm (1-1/2") wide nozzle to create a nominal 40 mm (1-1/2") wide homogeneous thermoplastic weld without interruption or defect. Use a minimum 20 mm (3/4") wide nozzle for corners, T-joints, patches and other field detailing, maintaining a nominal 20 mm (3/4") wide homogeneous thermoplastic weld. Some semi-automatic welding equipment utilize a 30 mm (1-1/4") wide nozzle; which is also acceptable.

1.4 MACHINE WELDING

AUTOMATED HOT-AIR WELDERS

Use a 40 mm (1-1/2") wide nozzle to create a nominal 40 mm (1-1/2") wide homogeneous thermoplastic weld without interruption or defect. In the absence of a working mud slab, a sheet metal or plywood substrate "track" should be placed under the membrane in order to run the welding equipment successfully. The width of the track will depend on the configuration and size of the welding equipment being used. The track can be either sacrificial or pulled out and leap-frogged in front of the welding equipment to provide a solid welding substrate for the entire length of overlap being welded. Welds shall be continu-

ous and without interruption or defect. Some automatic welding equipment utilize a 30 mm (1-1/4") wide nozzle; which is also acceptable.

AUTOMATED WEDGE WELDERS



Automated hot-air welder

Use a minimum 50 mm (2") wide, solid wedge to create a nominal 50 mm (2") wide homogeneous thermoplastic weld without interruption or defect. Membrane overlap width may need to be increased according to the requirements of the equipment. Prior to wedge welding in an underslab application, fold the active layer selvage edge of the bottom sheet back under and out of the way in order for the thermoplastic membrane of the bottom sheet to make contact with the wedge. After completing a thermoplastic weld, unfold the active layer selvage edge to provide minimum 100 mm (4") active layer to active layer overlap at the membrane overlap assembly and apply a continuous bead of CET-SEAL within the active layer. If the membrane is oriented yellow side up, lift up membrane or fold it back revealing the overlap in order to unfold the active layer selvage edge. When using automated wedge welders, never tack weld membranes together prior to machine welding.



Automated wedge welder

1.5 QUALITY CONTROL/INSPECTION OF WELDED SEAMS

1.5.1 COREFLEX TRAINED INSTALLERS

All installers welding the COREFLEX system membranes must be in possession of a Certified CoreFlex Welder ID Card issued by CETCO. This card must be current and on the person welding. The card indicates that the individual welding the CoreFlex membrane has suc-

cessfully completed the required CoreFlex training class. Individuals without a current Certified CoreFlex Welder ID Card may still assist with CoreFlex, but are not allowed to weld membranes on warranty eligible projects. Individuals without an active Certified CoreFlex Welder ID Card that are observed welding CoreFlex membrane may jeopardize the issuance and eligibility of the CETCO Warranty on that project. Contact your local CETCO sales representative with inquiries regarding the CoreFlex Training Class.

1.5.2 INSPECTING SEAMS

All welds shall be inspected by the waterproofing applicator's job foreman and/or supervisor on a daily basis. Inspection should take place only after the weld has had time to cool; probing a warm seam can damage the membrane. Weld continuity inspection shall include, but not be limited to, the probing of all field welds with a rounded flat head screwdriver or other dull pointed instrument (cotton pin puller). Drag the blunted tool along the cooled edge of the seam while applying gentle pressure. If any void or defect is found, immediately mark it so that it can be easily located and repaired. Prolonged use of a probing tool can restore an edge to the tool, so it will be necessary to occasionally re-round (dull) the probing tool.

Ensure that all aspects of the installation (sheet layout, attachment, welding, flashing details, etc.) are in strict accordance with current CETCO installation guidelines and details. Excessive patching of field seams due to poor workmanship will not be accepted at time of FINAL INSPECTION FOR WARRANTY ACCEPTANCE. Deviations from the specification and/or details must be authorized in writing by CETCO, prior to execution. Deviations from this procedure may result in forfeiture of warranty eligibility.

1.5.2 DAILY CALIBRATING OF WELDING EQUIPMENT

The daily process of calibrating welding equipment and an applicator's technique for the day's conditions is part of quality assurance. This step should be performed on a scrap piece of the same type of membrane that you are intending to install/weld. Ambient conditions should also be similar (test outside if you will be welding outside) to the field welding conditions. Repeat the calibration process as many times as necessary to dial the welding equipment in to achieve a proper, successful weld. Additional tests should be performed if the equipment sits idle for long periods of time and has been cooled or if weather conditions change during the day.

Testing shall be conducted on each piece of equipment, each day, and after each cool down (morning, after break, after lunch, etc.) on the project. Adjust equipment speed and or heat/power settings as necessary to achieve a proper weld. Poor weld results may also indicate an inadequate power source. It may be necessary to change to a different power source in order to achieve acceptable weld results.

1.5.3 COREFLASH NR

CoreFlash NR is a non-reinforced product that must be seam tested in a slightly different manner than COREFLEX. Inspect CoreFlash NR only after the welded area has cooled; inspecting while the membrane is still warm may lead to damage of the seam or membrane. Once

COREFLEX® THERMOPLASTIC WATERPROOFING WITH AN ACTIVE LAYER

cool, use a blunt instrument or finger to attempt to gently roll the edge of the CoreFlash NR away from the CoreFlash or COREFLEX that it is welded to. When welded appropriately, CoreFlash NR will not peel up or separate from the underlying membrane. If the CoreFlash NR peels up, apply additional heat and repeat the welding procedure to ensure a proper weld. After conducting the edge roll technique, still probe the entire weld with a blunt instrument to confirm weld continuity.

1.5.6 PROJECT TEST STRIPS AND DOCUMENTATION OF WELD

Each day, for each piece of equipment, cut out and retain a 50 mm–100 mm (2"–4") wide welded seam sample; date it and retain for the independent inspector/owners representative. Additionally a successful test strip, already pulled for verification of the weld process must be included. Similarly date and submit a successful test "pull strip" for the independent inspector. The independent inspector for the project will photo document the test strips for submittal to the CETCO Field Services Unit. Further test strips may be required as conditions change during the day, as problems arise, or at the independent inspector/owners representative discretion.

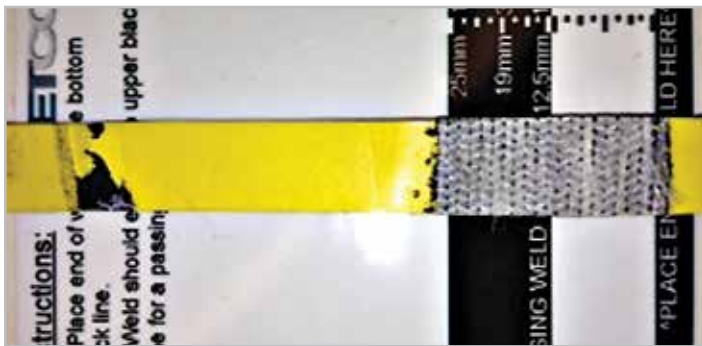

Weld needs to be greater than 12 mm

Taking samples of completed waterproofing should be avoided whenever possible. If a test cut is conducted on installed membrane, it must be patched properly. Test cuts shall be filled with Coretex extending 100 mm (4") beyond the edges of the cut opening (in order to provide a flush surface and replace the piece removed with the test sample. Next, patch the cut with CoreFlash extending 100 mm (4") beyond the edges of the cut opening and completed with a continuous thermoplastic weld.

1.6 INSTALLATION

In plaza deck or back-filled installation, install COREFLEX over properly prepared substrate with the active layer oriented in direct contact with the structural concrete. In a property-line wall/underslab application the active layer shall be facing the installer and the yellow thermoplastic portion of the COREFLEX membrane should be oriented down against the substrate. Overlap all adjoining edges a minimum of 100 mm (4"). All overlaps (factory long roll dimension edges, butt or short roll dimensions, and cut edges) require a minimum 100 mm (4") overlap of both the thermoplastic membrane and the active layer. COREFLEX overlaps must be assembled by fabricating a minimum

12 mm (1/2") wide continuous thermoplastic weld. (See Section 1.1 Membrane Welding Procedures for detailed instructions) If the slab is poured in sections, COREFLEX should extend a minimum 300 mm (12") beyond the slab edge. This enables COREFLEX to be properly overlapped for subsequent slab section pours. WATERSTOP-RX/XP should be installed in all applicable slab construction joints.

1.6.1 T-JOINT WELDING

Multiple thermoplastic membrane edge overlaps:

A CoreDisc or circular cut piece of CoreFlash NR with a minimum 100 mm (4") diameter is required, centered and hot-air welded at the T-Joint intersection using the following steps (COREFLASH, COREFLASH UV and COREFLEX are not acceptable T-Joint Patching materials.) CoreDiscs and CoreFlash NR conform better to the change in plane and efficiently seal the pinhole typically created when three reinforced membranes come together to form a T-Joint.

While hand welding the CoreDisc, use the edge of the hand roller to press in and conform the CoreDisc completely to the thermoplastic membrane overlaps.

SECTION 2 DETAILING

2.1 LARGE PENETRATIONS DETAIL SEQUENCING

PROPERTY-LINE/UNDERSLAB:

Install field sheet followed by CORETEX AFTER completing the following details.

BACK-FILLED WALLS/PLAZA DECK:

Install CORETEX followed by field sheet BEFORE completing the following details.

STEP 1: CUT & PLACE TARGET PIECE



STEP 1A. Cut target piece

Cut a square target piece of CoreFLASH that will extend a minimum 200 mm (8") radius around the penetration. Then cut an opening in the center of the target piece to fit tightly around the penetration.



STEP 1B. Place target piece

Slide the opening down the penetration to the substrate. The opening should be tight fitting and the COREFLASH will actually neck up onto the penetration approximately 6 mm (1/4").

STEP 2: CUT & POSITION NR

Cut a piece of CoreFlash NR wide enough to wrap around the penetration with an additional 50 mm (2") of overlap. Ideally the CoreFlash NR piece should be tall enough to extend a minimum of 200 mm (8") up the penetration from the substrate and flare out approximately 25 mm (1") onto the CoreFlash target piece. Therefore a minimum sizing of a CoreFlash NR piece to wrap a 200 mm (4") O.D. pipe will be approximately 375 mm x 225 mm (15" x 9"). Next round the two corners on bottom edge of the CoreFlash NR with a pair of scissors. With a handheld welder, heat the bottom edge of the CoreFlash NR to the point where it starts to curl towards the heat.



STEP 2A. Heat edge and stretch NR

Heat a 200–300 mm (4–6") section of the membrane. Stretch the membrane by pulling the edge of the CoreFlash NR in opposite directions along the heated edge of the membrane. Continue until the entire bottom edge of the CoreFlash NR and 75 mm (3") up the vertical edges of the CoreFlash NR is stretched. When done properly, the stretched edge should have a scalloped appearance



STEP 2B. Scalloped edge

This scalloped edge will form the flange against the CoreFlash target piece. Wrap the CoreFlash NR around the pipe so that it fits tightly and has a 50 mm (2") overlap running vertically on the penetration and a 25 mm (1") flange on the CoreFlash target piece on the substrate.

COREFLEX® THERMOPLASTIC WATERPROOFING WITH AN ACTIVE LAYER

STEP 3: TACK WELD NR



STEP 3. Tack weld NR

With a handheld welder (fitted with a 20 mm (3/4") tip) place a tack weld at the back of the 50 mm (2") overlap in two or three spots to hold the CoreFlash NR in place on the penetration. Be sure to keep the lowest tack weld up high enough to allow detailing the flange on the CoreFlash target piece first.

STEP 4: WELD NR TO TARGET PATCH



STEP 4. Final weld NR to target piece

Insert the tip of the welder at the base of the penetration between the CoreFlash NR flange and the COREFLASH target piece. Weld the flange to the target piece going around the base of the penetration until the entire flange is welded in place. Stretch the CoreFlash NR membrane slowly and gently in order not to tear it (may require 2-3 revolutions around the pipe.)

STEP 5: WELD VERTICAL NR STACK



STEP 5. Weld Vertical NR to target piece

Once the entire flange is welded in place, weld the vertical overlap seam up the penetration. Let the CoreFlash NR cool completely then probe the weld to verify the quality of the weld.

STEP 6: INSTALL LOWER HOSE CLAMP



STEP 6. Install lower clamp

Install a stainless steel hose clamp around the penetration 50 mm (2") down from the top edge of the CoreFlash NR and tighten it in place.

STEP 7: APPLY AKWASWELL BEAD



STEP 7. Install AKWASWELL bead

Insert a 9 mm (3/8") bead of AkwaSwell between the penetration and the CoreFlash NR tight to the stainless steel hose clamp.

STEP 8: INSTALL SECOND HOSE CLAMP



STEP 8. Install second clamp

Install a second stainless steel hose clamp above the first clamp and flush with the top of the AkwaSwell bead; and tighten it in place.

STEP 9: TRIM NR ABOVE TOP CLAMP



STEP 9. Trim NR above top clamp

With a utility knife trim the CoreFlash NR membrane tight to the top edge of the stainless steel hose clamp.

STEP 10: APPLY CETSEAL BEAD



STEP 10. Install CETSEAL termination

To finish the detail place a 6 mm (1/4") tooled bead of CETSEAL along the top edge of the CoreFlash NR.

STEP 11: PLACE AKWASWELL BEAD

Lift the COREFLASH target piece and place a bead of AkwaSwell, minimum 9 mm (3/8"), tight to the base of the penetration.

STEP 12: WELD TARGET PIECE

Weld the COREFLASH target piece to the COREFLEX field sheet with a minimum 12 mm (1/2") wide continuous weld.

COREFLEX® THERMOPLASTIC WATERPROOFING WITH AN ACTIVE LAYER

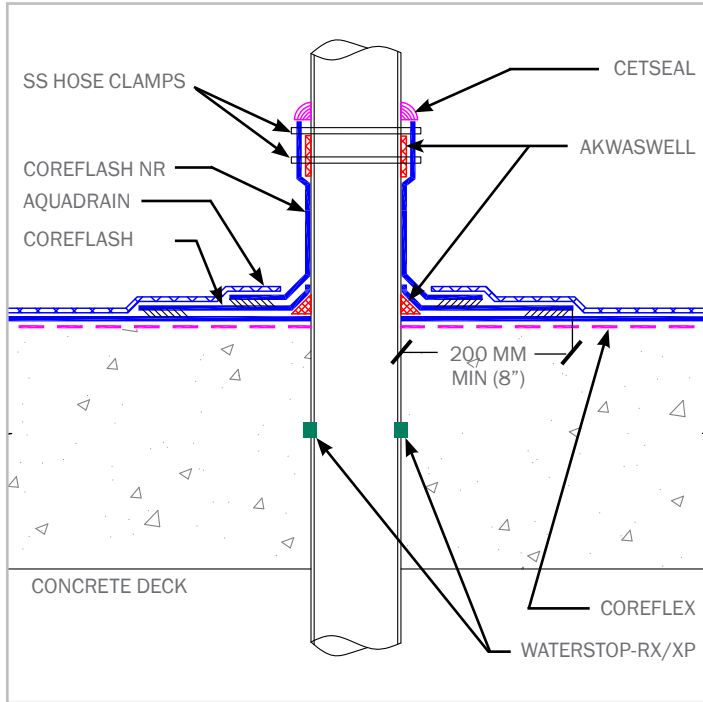

2.1.1 LARGE PENETRATION - PLAZA DECK/BACKFILLED WALL

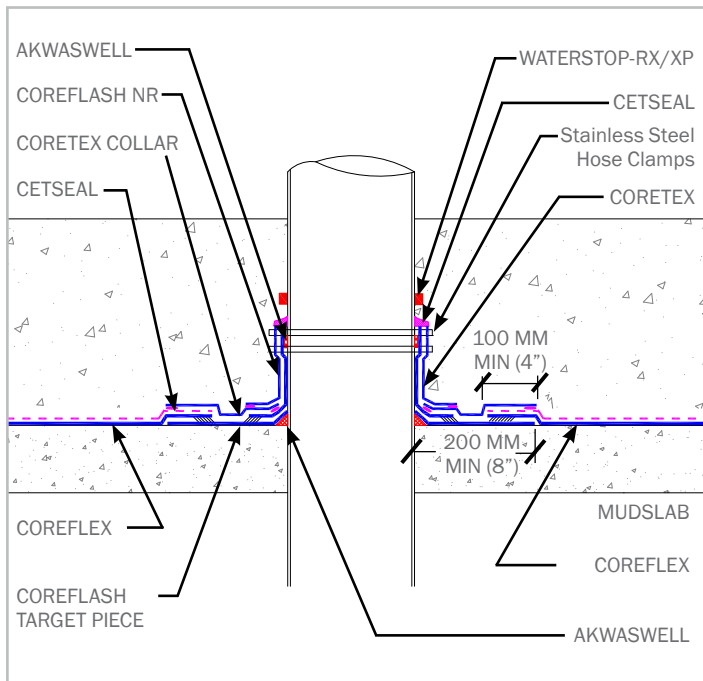

2.1.2 LARGE PENETRATION - UNDERSLAB/PROPERTY LINE WALL

2.2 ROUND PENETRATIONS

Use PF-340 for penetrations between 75 mm - 100 mm (3" - 4") diameter

Ensure the pipe is secured in its final position and is clean and free of dirt, debris, mastics and other items that may inhibit an efficient detailing process.

DETAIL SEQUENCING

PROPERTY-LINE/UNDERSLAB:

Install field sheet followed by CORETEX AFTER completing the following details.

BACK-FILLED WALLS/PLAZA DECK:

Install CORETEX followed by field sheet BEFORE completing the following details.

STEP 1: PLACE PF340 AROUND PIPE

Place the PF-340 tight around the pipe penetration with the base flange against the substrate.



STEP 1. Place PF340 around penetration

STEP 2: TACK WELD BASE FLANGE



STEP 2. Tack weld PF340 to fit penetration

Tack-weld the base flange overlap. Move to the non-reinforced stack and tack weld the overlap in place. If any adjustments need to be made in order to get a tighter fit around the penetration, do so prior to beginning the pre-weld in the overlap.

STEP 3: WELD PF-340



STEP 3. Weld PF340 overlap at base flange

With the reinforced base flange flush to the substrate complete a pre-weld and final continuous weld over the entire overlap seam of the PF-340 with a hot-air welder.

STEP 4: WELD OVERLAP UP STACK



STEP 4. Weld vertical overlap seam up stack

Weld the vertical overlap seam of PF-340 with a hot-air welder.

STEP 5: INSTALL FIRST HOSE CLAMP



STEP 5. Install lower clamp

Place the first stainless steel hose clamp around the pipe 50 mm (2") from the top of the non-reinforced stack and tighten in place. Non-reinforced stack flashing height and hose clamp placement is dependent upon the thickness of the slab/wall to be poured and can be decreased as applicable.

COREFLEX® THERMOPLASTIC WATERPROOFING WITH AN ACTIVE LAYER

STEP 6: APPLY AKWASWELL BEAD



STEP 6. Install AKWASWELL bead

Insert tip of AkwaSwell caulk tube between the non-reinforced stack and the pipe, placing a 9 mm (3/8") diameter ring of AkwaSwell continuously around the pipe tight to the stainless steel hose clamp.

STEP 7: INSTALL SECOND HOSE CLAMP



STEP 7. Install second hose clamp

Place a second stainless steel hose clamp over the non-reinforced stack and push the second stainless steel hose clamp down against the visible AkwaSwell bead and tighten the top hose clamp.

STEP 8: TRIM EXCESS



STEP 8. Trim excess membrane flush with top edge of clamp

Use a utility knife to trim any excess non-reinforced stack membrane flush with the top edge of the top hose clamp.

STEP 9: APPLY CETSEAL BEAD



STEP 9. Apply CETSEAL bead at termination

Place a 6 mm (1/4") tooled bead of CETSEAL where the top of the stainless steel hose clamp and non-reinforced stack meet.

STEP 10: APPLY AKWASWELL BEAD

When the overlap is completely welded, apply a 9 mm (3/8") bead of AkwaSwell under the reinforced base flange directly around the penetration at the substrate surface.

STEP 11: WELD TARGET PIECE

Weld the COREFLASH target piece to the COREFLEX field sheet with a minimum 12 mm (1/2") wide continuous weld.

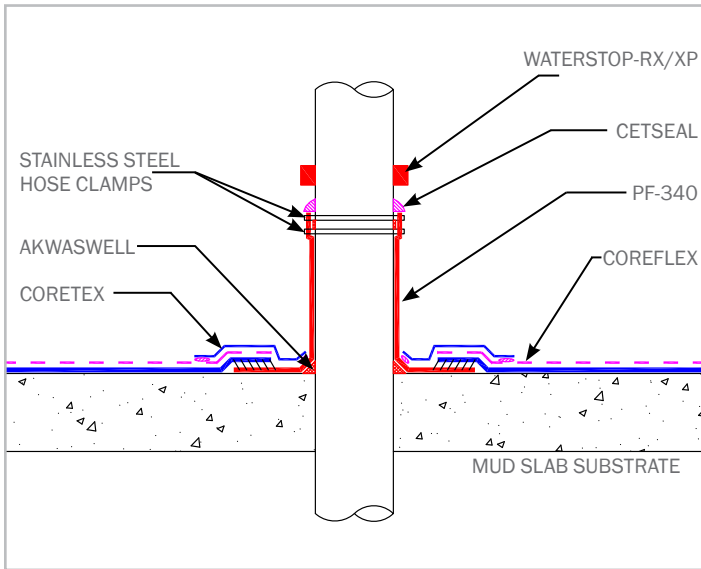

2.2.1 ROUND PENETRATION – UNDERSLAB/PROPERTY LINE WALL

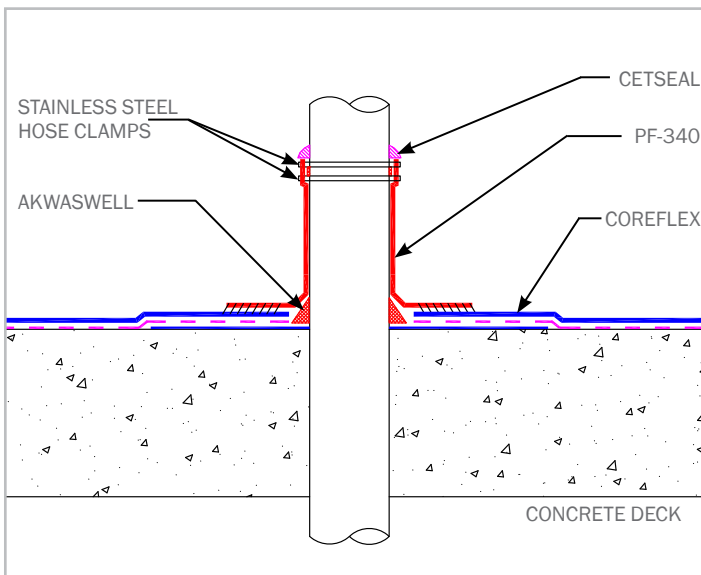

2.2.2 ROUND PENETRATION – PLAZA DECK/BACK FILLED WALL

2.3 ROUND PENETRATIONS

Use PF-150 for round penetrations 50 mm (2") diameter or smaller

Use the PF-150 pre-molded penetration flashing for round penetrations with a diameter less than or equal to 50 mm (2") (small diameter pipes, nelson studs, rebar, all-threaded rod, etc). The PF-150 incorporates a molded stepped profile that is sized for round penetrations 9 mm (3/8") to 50 mm (2") penetrations. Ensure that the penetration to be flashed is clean and free of debris.

DETAIL SEQUENCING

PROPERTY-LINE/UNDERSLAB:

Install field sheet followed by CORETEX AFTER completing the following details.

BACK-FILLED WALLS/PLAZA DECK:

Install CORETEX followed by field sheet BEFORE completing the following details.

STEP 1: INSTALL TARGET PIECE



STEP 1. Install COREFLASH target piece

Begin by placing a CoreFlash target piece over the element to be flashed; pushing the CoreFlash target piece flush with the substrate (shoring system, mudslab, etc). CoreFlash Target piece should be a minimum of 250 mm x 250 mm (10" x 10") to ensure a 100 mm (4") overlap of PVC to PVC with the COREFLEX field sheet.

STEP 2: AKWASWELL PLACEMENT



STEP 2. AKWASWELL placement

For penetrations smaller than 38 mm (1-1/2") place a bead of AkwaSwell on the first pre-molded "shelf" inside of the PF-150. Take care to keep the bead of AkwaSwell on this shelf only and not on the PF-150 flange that will be hot-air welded. For penetrations larger than 38 mm (1 1/2") place bead of AkwaSwell around the base of the element to be flashed.

COREFLEX® THERMOPLASTIC WATERPROOFING WITH AN ACTIVE LAYER

STEP 3: CUT PF150



STEP 3. Cut PF150 to size

Using a pair of scissors, cut the PF-150 at the appropriate pre-molded stepped shelf (one segment smaller than the diameter of the element to be flashed).

STEP 4: HEAT AND PLACE PF150



STEP 4A. Heat trimmed PF-150 cut end

With a hot-air hand welder heat the cut end of the PF-150 slightly and then slide the PF-150 over the protruding penetration until the flat flange is flush with the CoreFlash target piece.



STEP 4B. Placement of PF-150

Keep the PF-150 centered and AkwaSwell intact on interior shelf during placement.

STEP 5: TACK WELD PF-150 TO FLANGE



STEP 5. Tack weld PF-150 flange

With a hot-air hand welder, tack weld the PF-150 flange to the CoreFlash target piece at the interior of the flange.

STEP 6: LOOSLY PLACE HOSE CLAMP



STEP 6. Hose Clamp Loosely Installed

Place stainless steel hose clamp around the cut-end of the PF-150 and tighten the hose clamp to achieve a loose fit.

STEP 7: APPLY HEAT AND COLLAPSE



STEP 7. Hot-air applied to stepped stack

With a hot-air hand welder, apply heat uniformly around the exterior surface of the PF-150 stepped stack. Gently push the heated stack of the PF-150 towards the base flange causing the PF-150 to collapse upon itself.

STEP 8: SECURE THE HOSE CLAMP



STEP 8. Tightly secure hose clamp

Secure the hose clamp tightly not allowing the collapsed PF-150 to slide back out to original position.

STEP 9: WELD PF-150 TO COREFLASH



STEP 9. Weld the PF-150 flange to the COREFLASH

Working from the interior to the exterior of the flange edge, utilizing a hand held welder and silicon roller, weld the PF-150 flange to the CoreFlash target piece.

STEP 10: APPLY CETSEAL BEAD



STEP 10. Apply CETSEAL at termination

Then tool a bead of CETSEAL around the cut end of the PF-150; covering the cut end and terminating onto the penetrating element.

STEP 11: WELD TO COREFLEX

Weld the COREFLASH target piece to the COREFLEX field sheet with a minimum 12 mm (1/2") wide continuous weld.

COREFLEX®
THERMOPLASTIC WATERPROOFING WITH AN ACTIVE LAYER

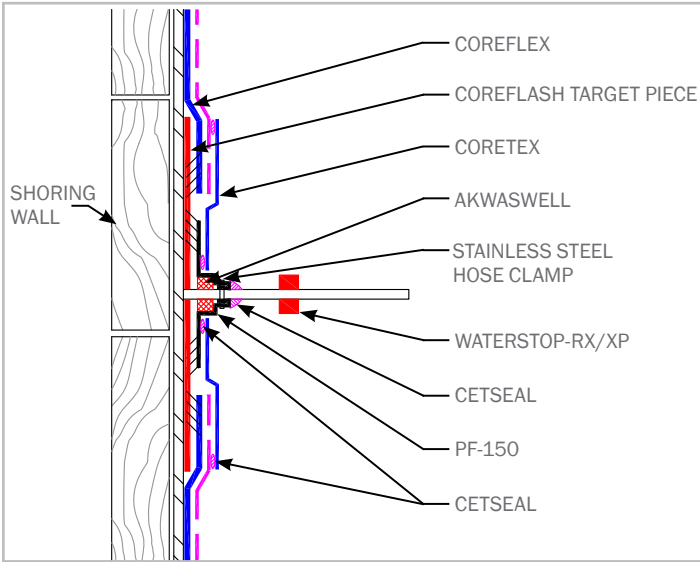

2.3.1 ROUND PENETRATION - UNDERSLAB/PROPERTY LINE WALL

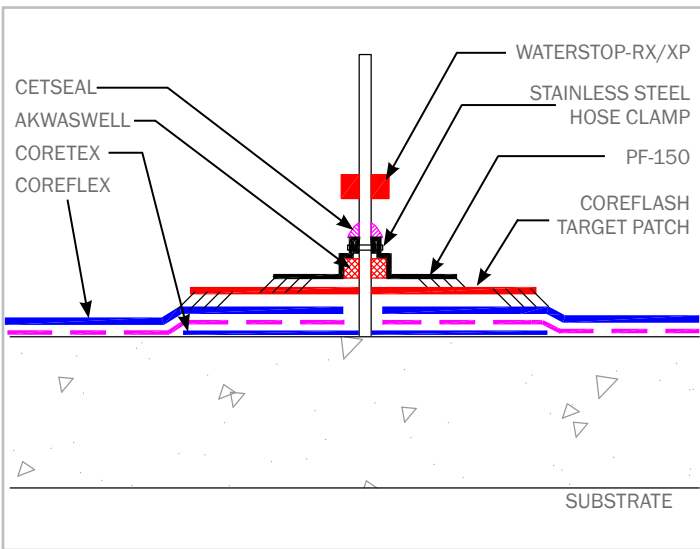

2.3.2 ROUND PENETRATION - PLAZA DECK/BACK FILLED WALL

2.4 SQUARE/RECTANGULAR PENETRATIONS

DETAIL SEQUENCING

PROPERTY-LINE/UNDERSLAB:

Install field sheet followed by CORETEX AFTER completing the following details.

BACK-FILLED WALLS/PLAZA DECK:

Install CORETEX followed by field sheet BEFORE completing the following details.

STEP 1: TARGET FLASHING



STEP 1. Target flashing

Cut a target piece of CoreFlash that is a minimum 400 mm (16") wide and long enough to entirely wrap the perimeter of the square penetration and overlap upon itself a minimum of 100 mm (4"). Wrap the CoreFlex target piece extending 200 mm (8") up the square penetration. Slit the membrane, from each corner of the square penetration, perpendicular to the long edge, allowing for the Coreflash to extend onto the substrate.

STEP 2: TACK WELD TARGET FLASHING



STEP 2. Target flashing tack weld

With the target piece of CoreFlash now extending 200 mm (8") up the penetration and the remaining 200 mm (8") onto the substrate, create an overlap a minimum 100 mm (4"). Tack weld the target piece in place, and form a continuous thermoplastic weld for the entirety of the seam.

STEP 3: PLACE CORNER TARGET PATCH



STEP 3. Place corner target patch

Cut four CoreFlash “L” shaped target patch pieces large enough to fill in the corners of the flanges so that there is a continuous flange around the penetration 300 mm (12”) from the base of the penetration out onto the substrate.

STEP 4: WELD ALL OVERLAP SEAMS



STEP 4. Weld target patch in place

Weld all overlaps of COREFLASH flashing piece and “L” shaped target piece.

STEP 5: PLACE UNIVERSAL CORNERS

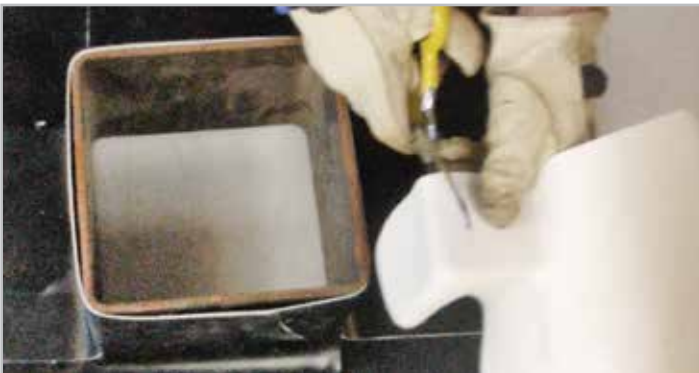

STEP 5A. Cut inside outside corner to fit

Place a Universal Corner Cut to fit the outside corner at each corner of the penetration (5a) and secure with a continuous thermoplastic weld (5b).



STEP 5B. Fully Weld Performed Corners to fit

STEP 6: REPEAT STEP 5 AT FOUR CORNERS



STEP 6. Install at all four corners

STEP 7: APPLY AKWASWELL

Place a 9 mm (3/8”) bead of AkwaSwell 25 mm (1”) in from the edge of the CoreFlash; between the CoreFlash and the penetration.

STEP 8: SECURE TERMINATION BAR

Secure the termination bar by fastening 200 mm (8”) OC so that the fasteners penetrate the membrane over the bead of AkwaSwell.

STEP 9: APPLY CETSEAL

Place a 6 mm (1/4”) tooled bead of CETSEAL at the outer edge of the termination bar.

STEP 10: CUT WINDOW AND PLACE

Cut a window in the CoreFlex that will fit over the penetration flashing overlapping the CoreFlash Flanges 100 mm (4”). Weld the COREFLEX to the CoreFlash flashing membrane with a thermoplastic weld. Install COREDISCS at all T-Joints. Cut a piece of Coretex and four square patches of Coretex the same dimensions as the pieces of CoreFlash described above and wrap it around the penetration securing it in place with beads of CETSEAL and as applicable wire ties.

COREFLEX® THERMOPLASTIC WATERPROOFING WITH AN ACTIVE LAYER

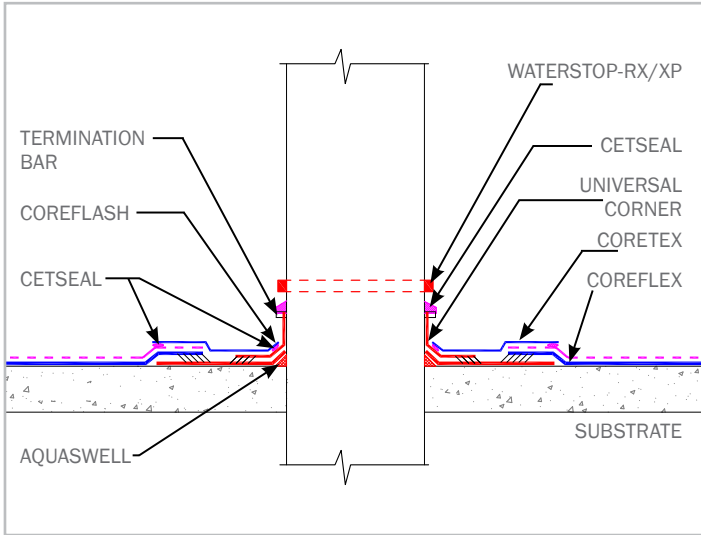

2.4.1 SQUARE PENETRATION – UNDERSLAB/PROPERTY LINE WALL

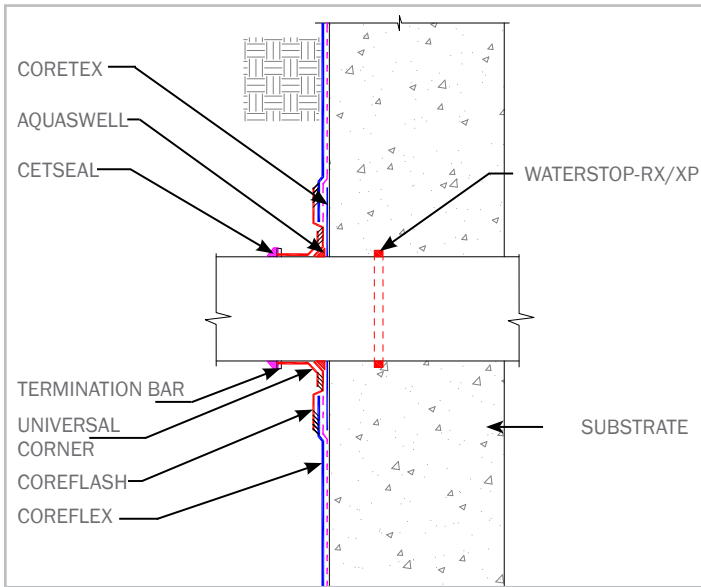

2.4.2 SQUARE PENETRATION – PLAZA DECK/BACKFILLED WALL

2.5 BUTT-JOINT DETAILING

BACK FILLED WALLS/PLAZA DECK: When joining two roll ends or cut ends of CORELEX membrane a butt splice constructed with COREFLASH and CORETEX is required. At both COREFLEX roll ends, install a minimum 450 mm (9") wide strip of Coretex extending up the face of the concrete wall from top of the footing to the grade elevation detail. Tuck edge of Coretex strip a minimum 100 mm (4") behind the trimmed/aligned COREFLEX roll edges and secure Coretex strip with washer-head fasteners along both edges maximum 900 mm (36") on center. **Do not secure Coretex strip fastened through COREFLEX membrane.** As applicable, overlap Coretex strip edges a minimum 100 mm (4") to provide continuous strip. Install adjacent COREFLEX membrane sheets overlapping exposed Coretex strip a minimum 100 mm (4"); leaving approximately 25 mm (1") of exposed Coretex between the two stacks of COREFLEX roll ends. Closely match roll ends to 25 mm (1") of adjacent COREFLEX roll end. Secure COREFLEX roll ends with washer-head fasteners placed through the Coretex strip. Install minimum 450 mm (9") wide strip of CoreFlash flashing over the COREFLEX centered along the Coretex strip detail (yellow side facing installer). Hot-air weld both edges of the CoreFlash strip to the COREFLEX; both continuous welds must be outside of all fasteners (no exposed fasteners). CoreFlash strip shall extend a minimum 100 mm (4") over both COREFLEX membrane edges. Finish CoreFlash strip by hot-air welding a CoreDisc or CoreFlash NR patch over all T-Joints.

Underslab/Property Line Walls:

Repeat the procedure outlined for backfilled walls/plaza deck; first install the COREFLASH with thermoplastic welds then adhere CORETEX with continuous beads of CETSEAL.

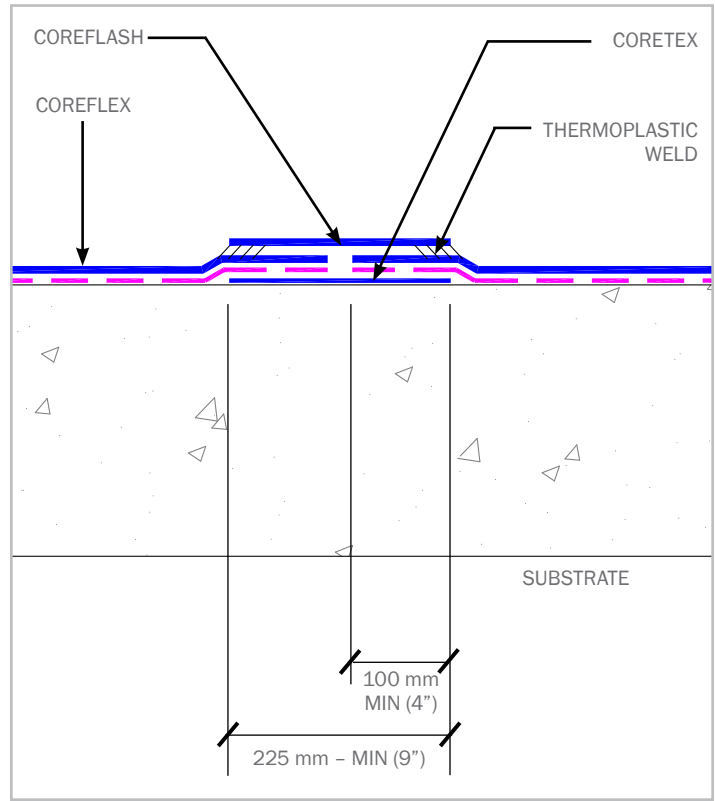

2.5.1 BUTT-JOINT DETAIL PLAZA DECK/BACKFILLED WALL

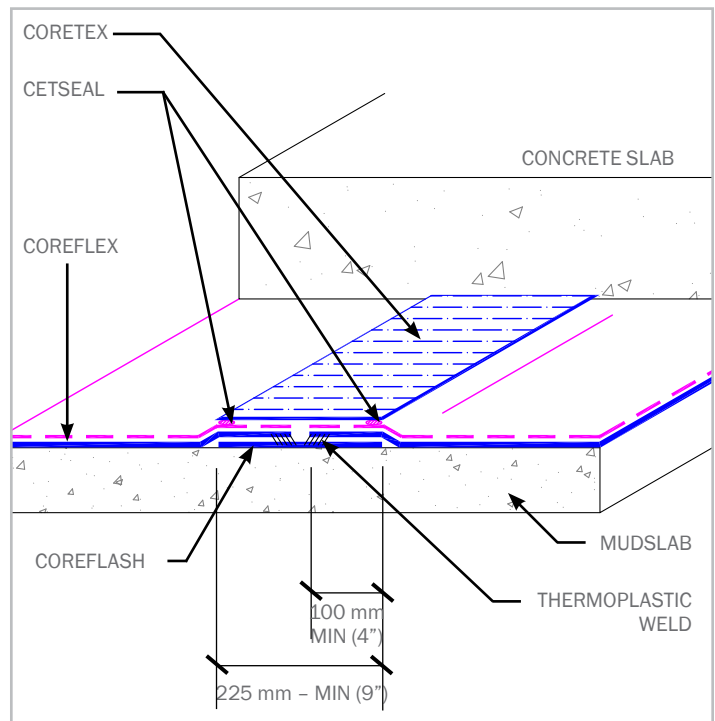

2.5.2 BUTT-JOINT DETAIL UNDERSLAB/PROPERTY LINE WALL

COREFLEX® THERMOPLASTIC WATERPROOFING WITH AN ACTIVE LAYER

2.6 GRADE TERMINATION

Coordinate work with excavation and backfill operations conducted by others to remove the top elements of the shoring retention wall per local building code or as specified in the contract documents. Identify and repair any waterproofing and/or drainage sheet damaged by excavation and removal of the top shoring retention wall elements. Fasten top edge of COREFLEX membrane 300 mm (12") below finished grade elevation with washer-head fasteners maximum 300 mm (12") on center. Install CoreFlash UV grade flashing membrane with bottom edge overlapping COREFLEX membrane a minimum 100 mm (4"); use Adhesive SB-100 to adhere CoreFlash UV flashing membrane continuously to substrate (except for top 50 mm (2")). Roller apply Adhesive SB-100 to both the black side of the CoreFlash UV and the substrate area at a coverage rate of 1.2 m²/liter (50 ft² per gallon). This equates to 1.2 m²/0.5 liter (50 ft² per 1/2 gal.) to the substrate and 1.2 m²/0.5 liter (50 ft² per 1/2 gal.) to the membrane. Actual adhesive coverage depends upon the porosity and smoothness of the surface and workmanship. To insure proper application and curing of the adhesive, outside air temperature should be 4 °C (40 °F) and rising. Roll or trowel a smooth, even coat of the adhesive over the black bottom side of the CoreFlash UV and the area of the substrate to receive the flashing, ensuring 100% coverage. Allow the adhesive to set to the point that the adhesive becomes stringy to the touch. When sufficiently set, carefully place the adhesive coated side of the CoreFlash UV membrane onto the adhesive coated substrate. Roll or hand press membrane to substrate to ensure full contact and a continuous bond. Secure bottom edge CoreFlash UV to COREFLEX with a continuous thermoplastic weld. Overlap adjacent CoreFlash UV roll ends a minimum 100 mm (4") and seal with continuous thermoplastic weld. Terminate top edge of CoreFlash UV flashing membrane at elevation per project details and specifications. Apply CETSEAL 50 mm (2") wide x 2.3 mm (90 mil) thick behind the top, non-adhered edge of CoreFlash UV grade flashing. Then secure top edge of CoreFlash UV with termination bar fastened into substrate maximum 300 mm (12") on center. Complete grade termination detail with tooled bead of CETSEAL along the top edge and at all penetrations through the flashing. Counter flash or cover the termination per project specifications.

Backfill should consist of compactable soils, pea gravel, or crushed stone (19 mm (3/4") or less). Avoid backfill with aggregate larger than 40 mm (1.5"). Backfill should be added in 150–300 mm (6" to 12") lifts and compacted to a minimum 85% Modified Proctor density. If gravel backfill, specify angular aggregate <19 mm (3/4") with fines.

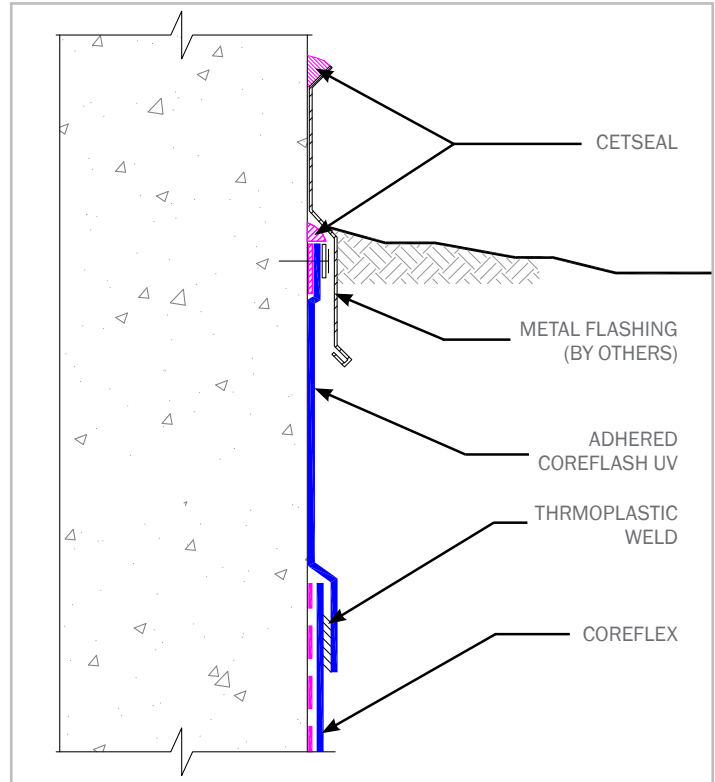

2.6.1 GRADE TERMINATION - STANDARD

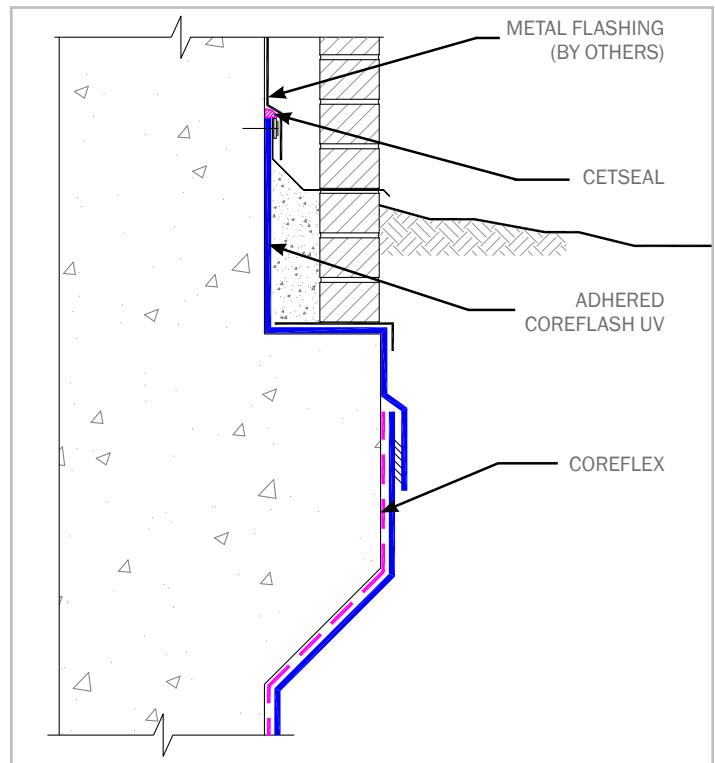

2.6.2 GRADE TERMINATION - THRU-WALL FLASHING

2.7 PROPERTY LINE SHORING WALL TO SLAB TRANSITION

SLAB TO WALL TRANSITION:

Where property line retaining walls, such as soldier pile and lagging, are used as the outside form, it is very important to extend the waterproofing a minimum 300 mm (12") above the top of the slab since there is no access to the outer edge of the slab after it is poured.

SLAB TO WALL CORNER TRANSITION:

Install COREFLEX sheet horizontally oriented (active layer side facing installer), membrane PVC selvage edge up with a minimum 300 mm (12") of the sheet extending out onto the horizontal substrate. These dimensions may be increased to allow for securement of the COREFLEX membrane to fall outside of gaps in the lagging or to allow room for use of automated welding equipment.

Install COREFLEX sheet to shoring wall along the top edge of the thermoplastic selvage edge, secure with washer-headed fasteners approximately 25 mm (1") from the top edge of the membrane; maximum 900 mm (3') on center. Adjacent edges of COREFLEX sheets should be overlapped and detailed per guidelines in Section 1.1 Membrane Welding Procedures.

If the slab thickness is greater than 750 mm (30") install a second full sheet of COREFLEX, horizontally oriented, to meet the 300 mm (12") requirement above the slab. Overlap top edge of previous sheet and edges of adjacent sheets for both the thermoplastic membrane and active layer a minimum of 10 mm (4").

SLAB TO WALL CORNER TRANSITION (ALTERNATIVE INSTALLATION METHOD):

Install a strip of COREFLASH horizontally oriented, with a minimum of 300 mm (12") of the sheet extending out onto the horizontal substrate. These dimensions may be increased to allow for the securement of the membrane to fall outside of gaps in the lagging or two allow room for use of automated welding equipment. Place and secure the COREFLASH into the corner transition. Place COREFLEX on the horizontal substrate allowing for a minimum overlap of 100 mm (4") over the horizontal flap of COREFLASH. Secure the COREFLEX to the COREFLASH with a continuous thermoplastic weld. Then secure COREFLEX, either vertically or horizontally, to the shoring wall so that it overlaps the COREFLASH a minimum of 100 mm (4"). Secure the top edge COREFLEX fastened to the shoring wall to the top edge of COREFLASH with a continuous thermoplastic weld.

To complete the slab to wall transition, install CORETEX over all COREFLASH transition strips; overlap active layer of COREFLEX a minimum of 100 mm (4") and secure CORETEX edges and sheet with continuous beads of CETSEAL.

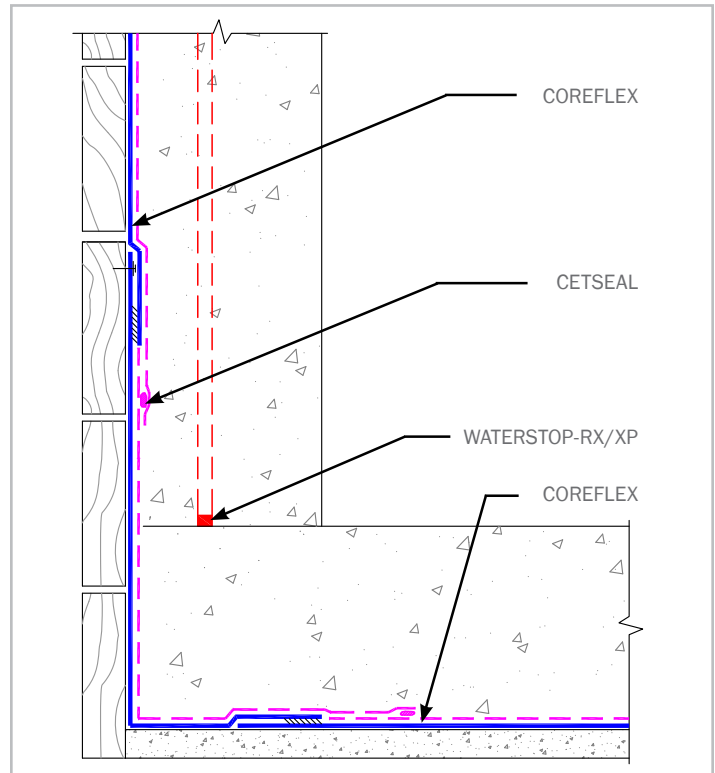

2.7.1 SLAB TO WALL TRANSITION - PROPERTY LINE WALL

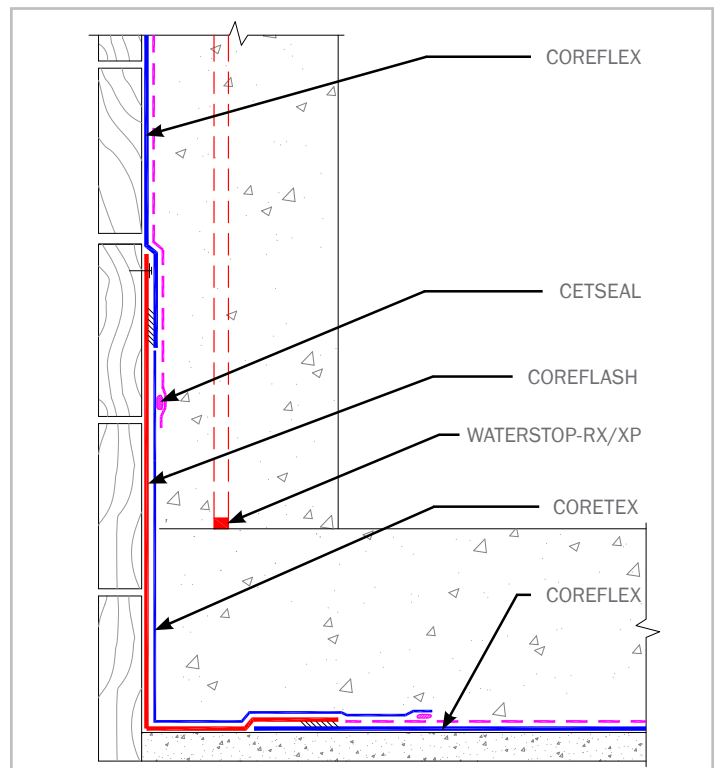

2.7.2 ALTERNATIVE METHOD SLAB TO WALL TRANSITION

COREFLEX® THERMOPLASTIC WATERPROOFING WITH AN ACTIVE LAYER

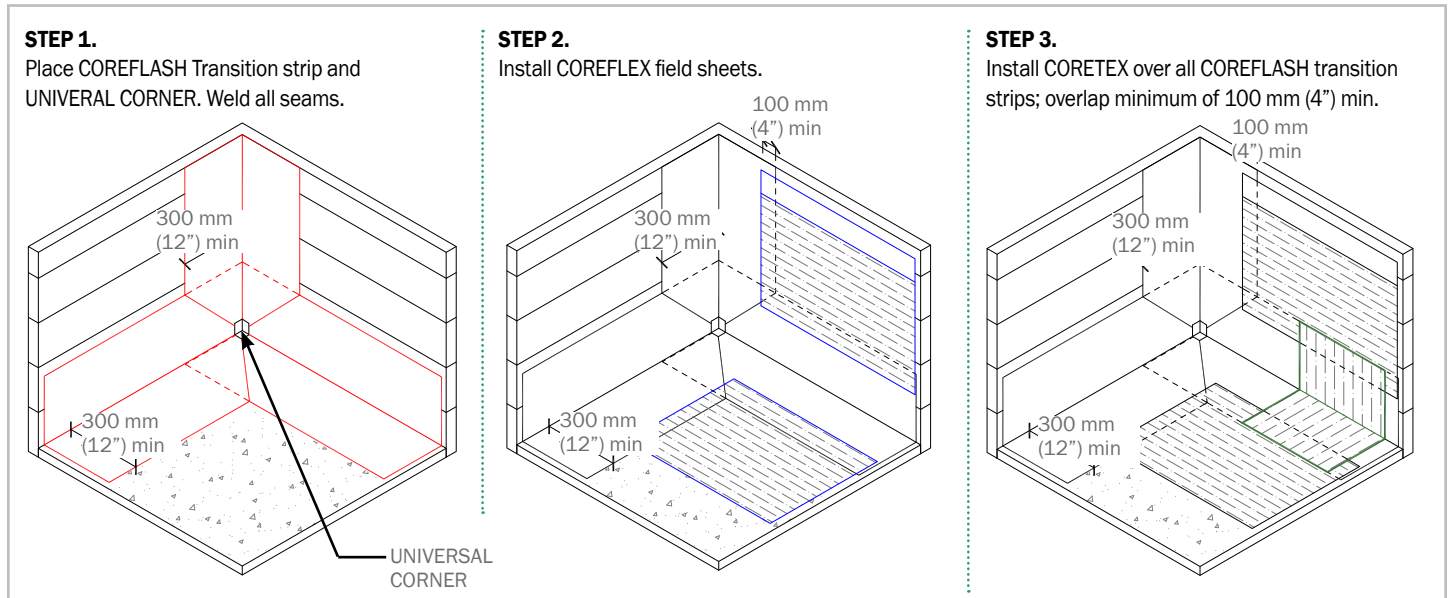

2.7.3A SLAB TO WALL TRANSITION – ALTERNATIVE METHOD SEQUENCING

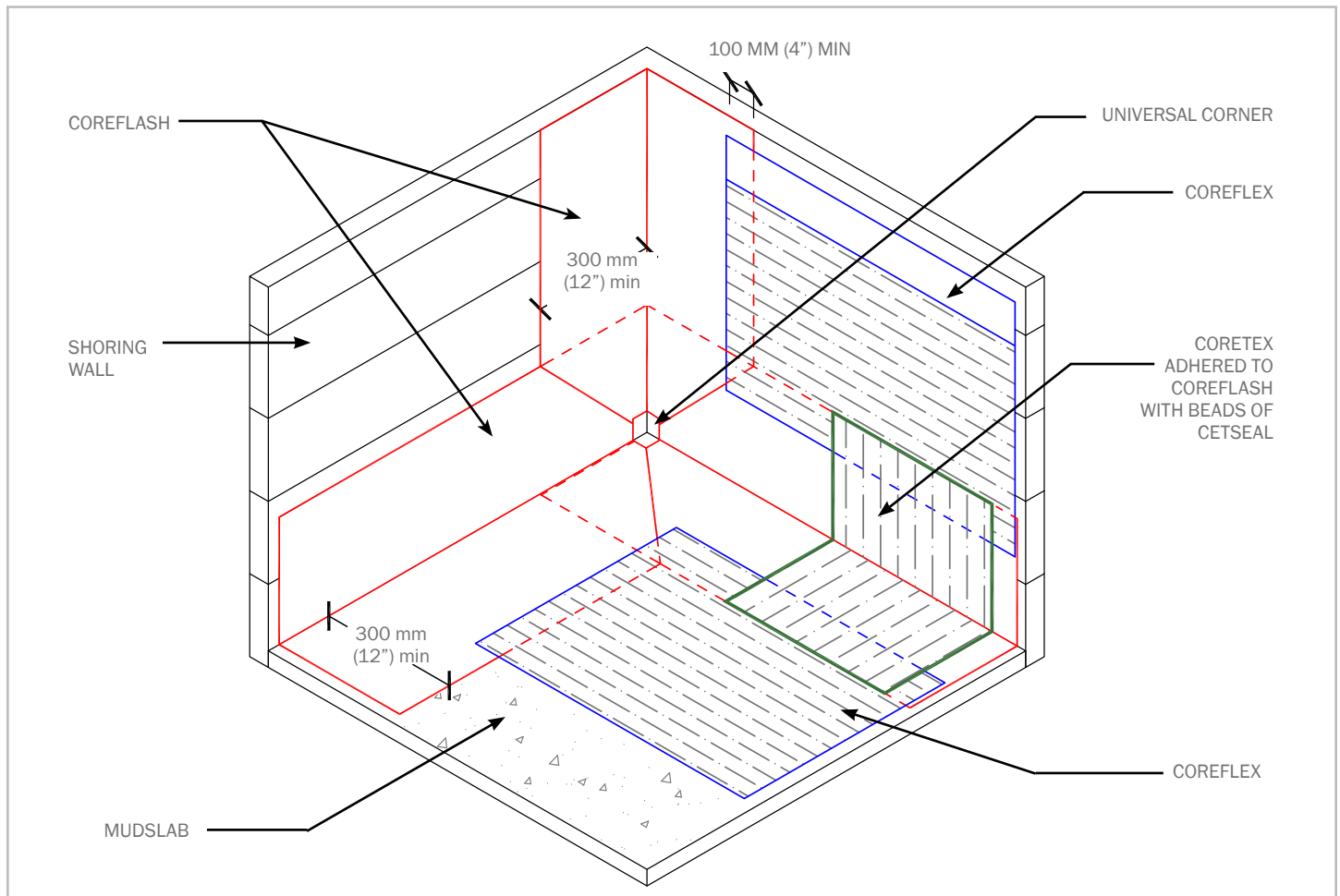

2.7.3B SLAB TO WALL TRANSITION – ALTERNATIVE COMPOSITE

2.8 BACK FILLED WALL – EDGE OF SLAB

When the installation reaches the edge of the slab, extend the COREFLEX sheet out the top of the form a minimum of 300 mm (12"). At the slab edge, COREFLEX should remain in contact with the substrate and the inside surface of the concrete form conforming tightly to the change in plane. After concrete placement, position COREFLEX mem-

brane to top of footing and secure with washer headed fasteners maximum 200 mm (8") on center. Damaged material outside the form should be patched or cut off and disposed. Install SEAL-X XP cant at wall-to-footing transition prior to installing COREFLEX wall waterproofing overlapping the secured COREFLEX edge on top of the footing a minimum 100 mm (4"); secure with a continuous thermoplastic weld.

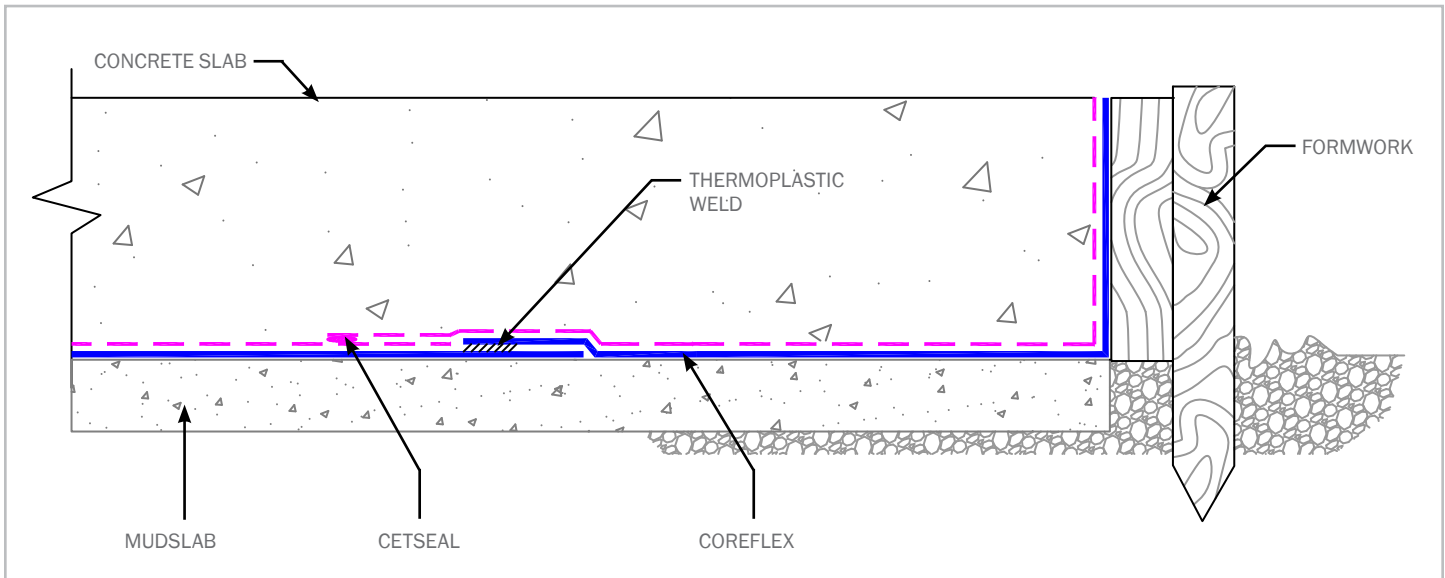

2.8.1 PERIMETER SLAB EDGE

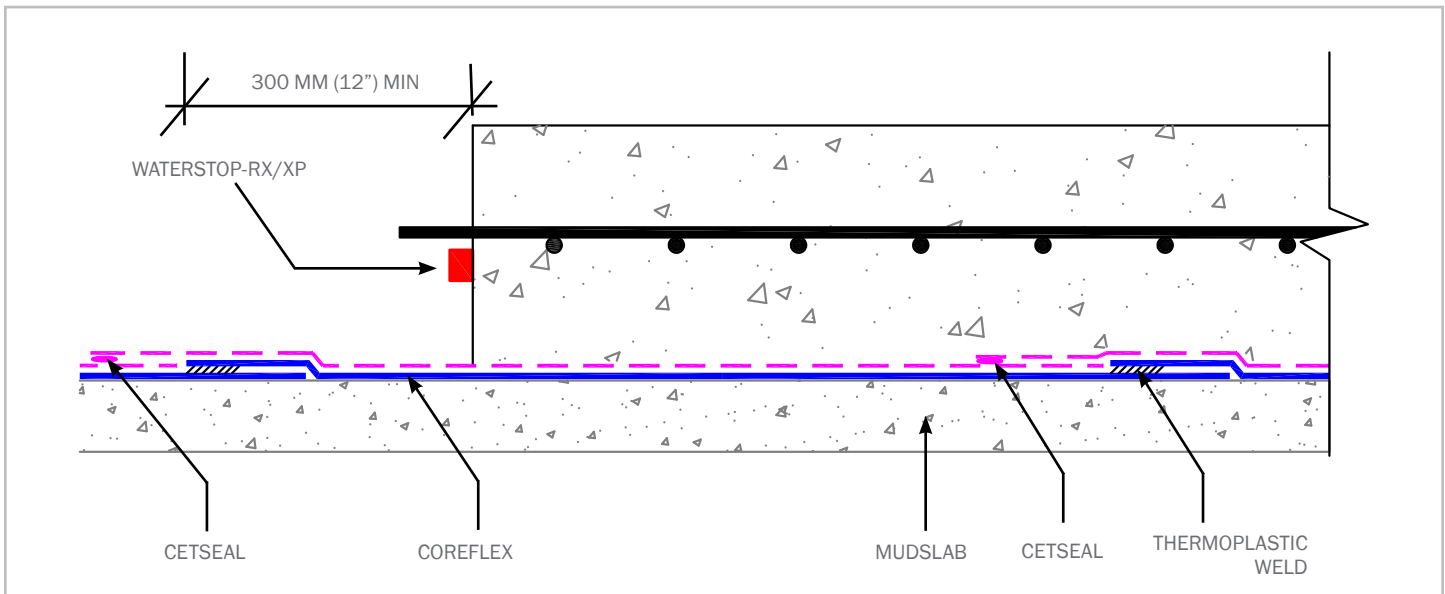

2.8.2 SLAB SECTION TIE-IN

COREFLEX®

THERMOPLASTIC WATERPROOFING WITH AN ACTIVE LAYER

SECTION 3 UNDERSLAB INSTALLATION METHODS

3.1 GENERAL

Best practice is to install COREFLEX on a smooth concrete mud slab with a float finish to provide a planar surface; without sharp angular depressions, voids or raised features. The COREFLEX system is intended for use under reinforced concrete slabs 150 mm (6") thick or greater with a mud slab substrate. COREFLEX can be used under reinforced concrete slabs 100 mm (4") thick or greater with a compacted earth/gravel substrate. For installation over compacted earth or gravel substrates, consult CETCO for additional steps required for the field fabrication of welded overlap seams. For hydrostatic conditions, install COREFLEX under footings and grade beams. For non-hydrostatic conditions, COREFLEX should be installed around footings and grade beams and completed with a termination bar and a tooled bead of CETSEAL.

Prior to installing COREFLEX the substrate must be properly prepared. Complete all required elevator pit, sump pit, cistern, grade beam and piling work prior to installing COREFLEX under the slab area. These areas shall be correctly tied into the underslab COREFLEX to form a monolithic system. How these items are formed, poured and finished are critical to proper detailing. Penetrations should be placed and secured in their final position prior to installing COREFLEX membrane so that they may be properly detailed. All corrective actions required to provide a suitable substrate must be completed prior to the installation of the COREFLEX waterproofing membrane and components.

3.2 SUBSTRATE PREPARATION

The preferred substrate is a working mud slab, but may also be compacted earth, sand, or crushed stone. Earth and sand substrates should be compacted to a minimum 85% Modified Proctor density. Crushed stone should be no larger than 19 mm (3/4") in size. Substrate should be smooth and without sharp deflections or pockets. Substrates other than a working mud slab require additional steps and components to properly complete the welded overlap assembly (See Section 1 Membrane Welding Procedures for detailed instructions). Earth formed elevator pits, grade beams and footers require soils that are stable enough to support the COREFLEX membrane and provide for adequate confinement. For piles, detailing is required prior to pouring the pile caps. When earth formed, the topmost 200 mm (8") minimum of the pile should be formed with a round cardboard tube type form to provide a smooth concrete surface for detailing.

3.3 GRADE BEAMS, FOOTINGS AND ELEVATOR PITS

Grade beams, footings and elevator pits are typically lined and poured prior to pouring the working mud slab. Any unstable or non-compatible

soils should be contained with a retaining wall. COREFLEX should be installed on the vertical surfaces and on the substrate below the slab to form a continuous envelope around the grade beam or elevator pit. Install COREFLEX membrane directly against the retaining wall. Substrate requirements for grade beams, footings and elevator pits are identical to the requirements for suitable substrate for all other surfaces to receive COREFLEX membrane waterproofing. The surface must be smooth and planar, and ridged enough to provide for proper confinement. The substrate must also provide adequate fastening grip, to support the membrane. Place the membrane into the grade beam, footing or elevator pit so that the active layer is facing the installer. In corners, apply the waterproofing using CoreFlash and Coretex separately then adhering them together with CETSEAL after welding the CoreFlash. This will allow for tighter conformity of the waterproofing to the changes in plane. It will also provide for easier welding, negating the need to peel the active layer from the thermoplastic membrane. Alternately, pre-fabricating a COREFLEX membrane liner, off-site or on-site but on a slab or other ridged planar substrate should be considered. Prefabricated pieces should then be placed and assembled in the grade beam, footing or elevator pit, greatly reducing the number of welds made on a compacted fill, sand or gravel surface requiring the use of a metal or wood track to accommodate the welding equipment.

Field prefabrication can be accomplished by building a mockup of the same dimensions of the grade beam, footing or elevator pit and constructing it so that the COREFLEX is placed on the outside of the mockup allowing the welding to be completed on the yellow thermoplastic side of the membrane. The prefabricated piece then can be pulled off the mockup and placed into the grade beam, footing or elevator pit. When transitioning to a mud slab, allow a long enough membrane (tails) to extend out onto the mud slab and tie into the underslab COREFLEX membrane; typically 300 mm (12").

When tying into a column from a grade beam, it is necessary to wrap the COREFLEX membrane coming up the sides of the grade beam and onto the top of the grade beam bringing the COREFLEX membrane up to and cut tight to the column. Flash the corners per the site specific detail at the juncture of the grade beam to the column. A secondary (upside down) flashing at the corners needs to be placed prior to pouring the mud slab in order to flash the underslab COREFLEX membrane to the column flashing membrane. Due to various elevator piston plunger designs, consult CETCO for specific installation and detailing recommendations for piston plungers that penetrate the pit slab.

3.4 PILE CAPS

The pile portion of a pile cap is typically earth formed and may not provide a suitable smooth substrate to install the flashing components. When earth formed, the top 200 mm (8") minimum portion of the pile should be formed with a round cardboard tube form in order to provide a smooth substrate for detailing. This top, smooth portion of the pile is then detailed as a round or square penetration per section 2.

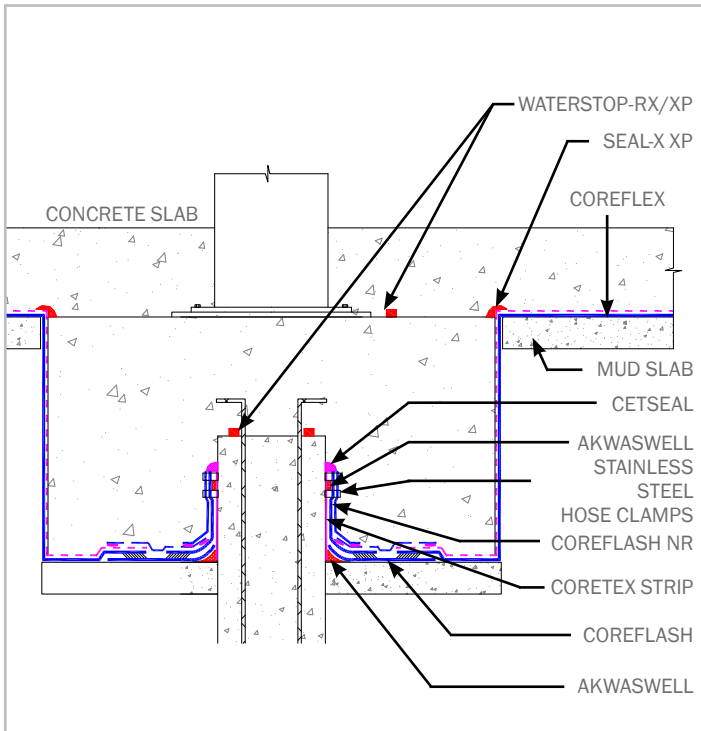

3.1.1 UNDERSLAB GENERAL - PILE CAP

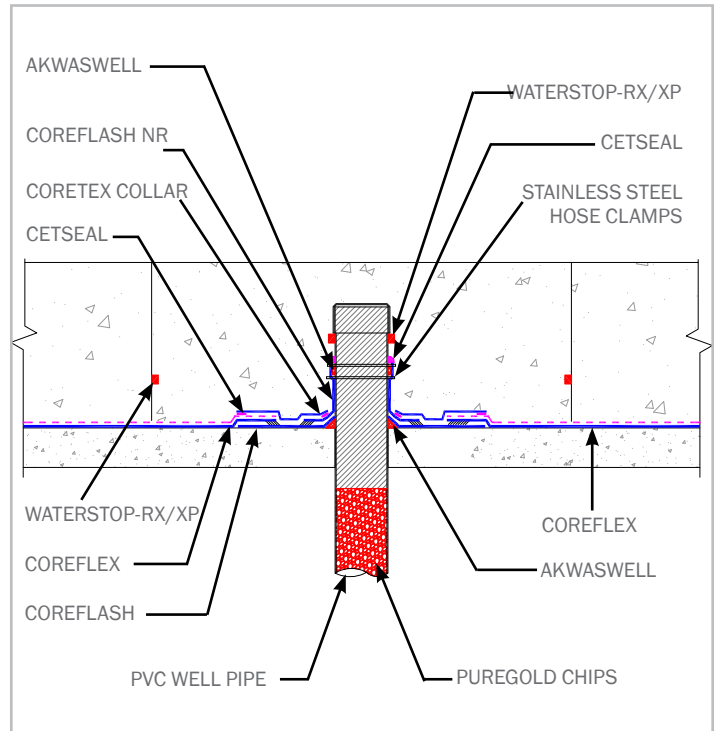

3.1.2 UNDERSLAB GENERAL - WELLPOINT BOX OUT

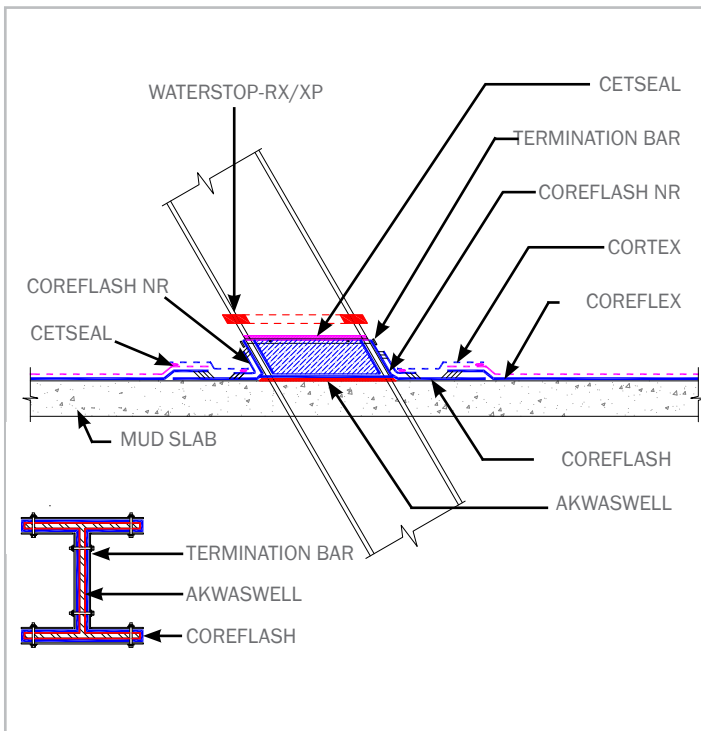

3.1.3 UNDERSLAB GENERAL - RAKER

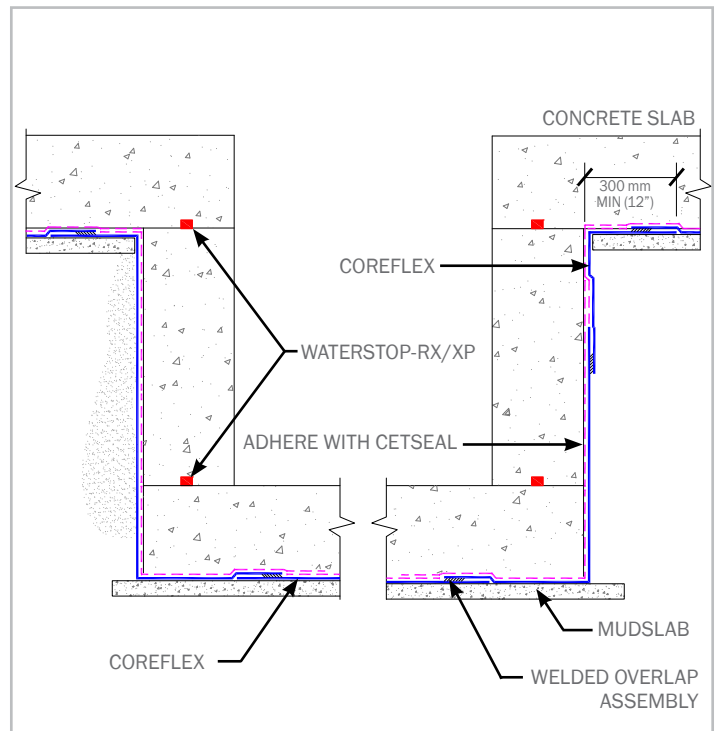

3.3.4 UNDERSLAB GENERAL - ELEVATOR PIT

COREFLEX®

THERMOPLASTIC WATERPROOFING WITH AN ACTIVE LAYER

SECTION 4 PROPERTY LINE CONSTRUCTION

4.1 GENERAL

The use of construction techniques described in this section allow the exterior building dimensions to coincide with a shoring wall at the property line, thereby maximizing use of available land for building. COREFLEX has been proven to be one of the most effective means for waterproofing property line construction. Property line construction methods include soldier pile & lagging, metal sheet piling, earth formed shotcrete retention walls, and auger cast caisson walls.

For all property line construction methods, install COREFLEX with the APC/XP layer (active layer) side oriented inward (facing the installer) so that the concrete will be poured against the active layer side. Aquadrain sheet and 100BD base drain composite system should be connected to an operative water discharge system (sump pump or gravity to daylight discharge).

Protect waterproofing products from damage before material is contained with concrete or backfill. After any precipitation, standing water should be pumped off of the waterproofing as soon as possible.

4.2 SHORING WALL PREPARATIONS

Excavation work should provide a shoring wall in good condition to receive waterproofing system. Appropriate preparation can vary per shoring wall type. Verify the substrate preparation work has been completed for the applicable shoring wall system. Then install COREFLEX following the "Property Line Wall Installation" Guidelines in Section 4.3.

4.2.1 SOLDIER PILE & LAGGING SHORING WALL

Gaps between wood lagging timbers should be no wider than 25 mm (1"). If the gaps between lagging timbers are in excess of 25 mm (1"), the gaps should be completely filled with cementitious grout, wood, extruded polystyrene 0.138 MPa (20 psi) min. spray foam or compacted soil. If water is flowing through the lagging, thin polyethylene sheeting can be installed over the area before COREFLEX is installed.

In areas with large gaps of up to 63 mm (2-1/2") between lagging, Aquadrain sheet drainage composite can be installed over the lagging to provide a uniform surface to mount COREFLEX. Securely fasten Aquadrain to the lagging surface with washer-head fasteners before installing COREFLEX. Gaps larger than 63 mm (2-1/2") between lagging should be completely filled with grout, wood, extruded polystyrene 0.138 MPa (20 psi) minimum spray foam or compacted soil even if Aquadrain is installed prior to COREFLEX. Do not use plywood or other surface treatment over large lagging gaps that leave the cavity void. Wood lagging shoring should extend to the lowest level of the waterproofing installation without any voids or cavities exterior of or under-

neath the lagging filled with compacted soil or cementitious grout. Voids or cavities at tie-backs should be filled with grout or compacted soil prior to COREFLEX installation.

SOLDIER PILE STRIPPING: Install a protective material strip of CoreFlash over all soldier piles with raised lagging hanger bolts, form tie rods, or other irregular surfaces to provide a suitable substrate that will not puncture the COREFLEX. The CoreFlash strip should extend a minimum 100 mm (4") to both sides of the piling.

CEMENTITIOUS BOARD: Prior to installing membrane to Grade Termination detail at finished grade, install 12 mm (1/2") thick cementitious wall board centered over steel soldier pile from finished grade elevation to past the specified depth that the top of steel soldier pile and wood lagging will be removed.

4.2.2 METAL SHEET PILING SHORING WALL

PLYWOOD OR CEMENTITIOUS WALL BOARD METHOD (RECOMMENDED METHOD)

Use 12 mm (1/2") plywood or cementitious wall board fastened to the sheet piling to create a flat surface upon which COREFLEX can be installed. All void spaces between the plywood/cement board and sheet piling must be filled with compacted earth or concrete.

Installation of COREFLEX directly to and contouring the sheet metal piling requires special knurled powder-actuated fasteners to secure COREFLEX to the metal sheet piling. All fasteners must be positioned to be outside of all thermoplastic welds.

Fill voids or cavities at tieback plates with cementitious grout or compacted soils. If excessive water is penetrating the sheet piling knuckles, BentogROUT can be injected to the outside of the knuckle to stop water flow. Consult CETCO for BentogROUT application and installation guidelines.

For metal sheet pile shoring wall place a continuous band of cementitious board at the point where the sheet pile and or piles are to be burned off. The cementitious board should extend a minimum 450 mm (18") below the point where the sheet pile and or piles are to be burned off.

4.2.3 EARTH-FORMED DIAPHRAGM SHORING WALL

The surface of the earth-formed diaphragm wall must be sufficiently planar to provide an adequately smooth surface to apply COREFLEX. COREFLEX can be applied over large, relatively shallow indentations. The surface should not contain voids or sharp protrusions in excess of 25 mm (1"). Fill all voids with cementitious grout or shotcrete and remove protrusions prior to installing COREFLEX.

Shotcrete must be well consolidated and contain no honeycombed areas or voids. These types of defects must be corrected prior to installing the COREFLEX membrane.

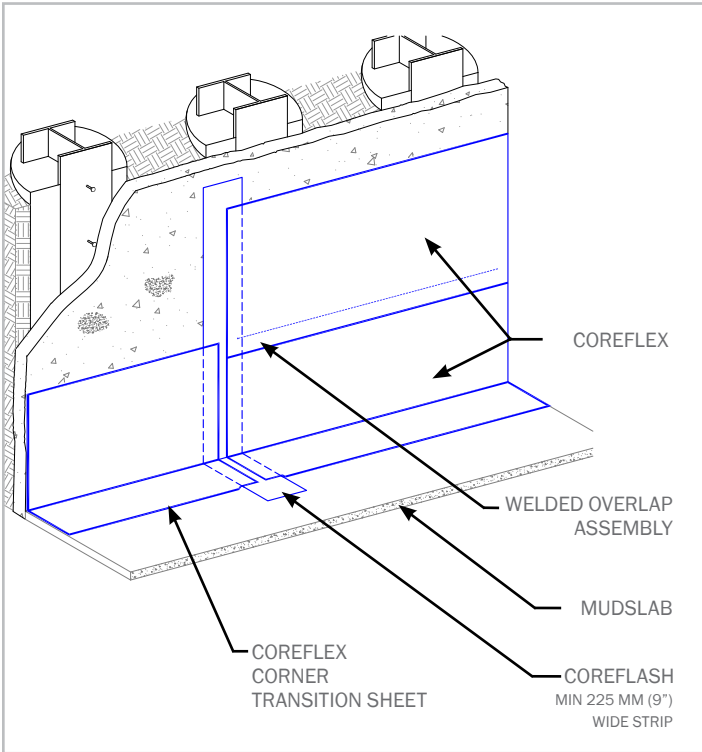

4.2.4 PROPERTY LINE WALL - AUGER CAST CAISSON

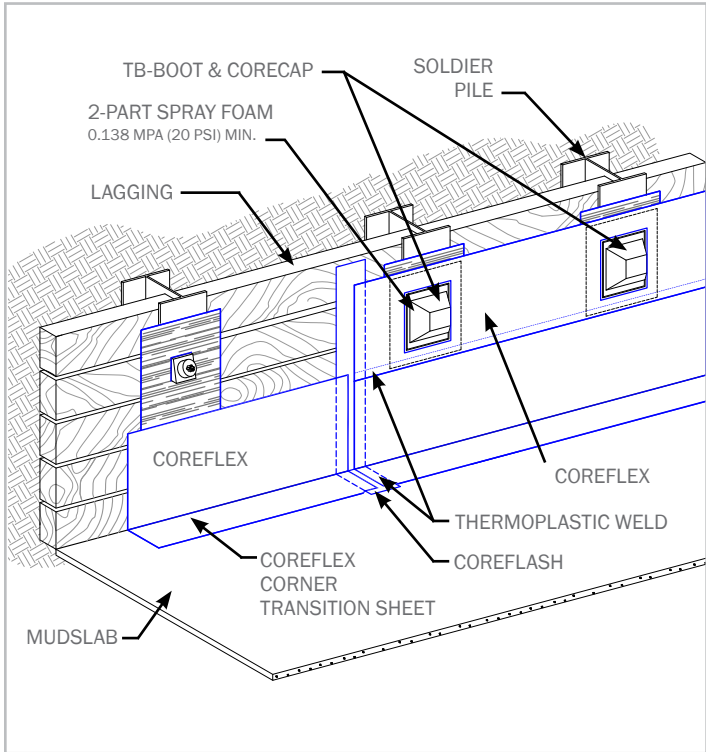

4.2.4 PROPERTY LINE WALL - SOLDIER PILE & LAGGING

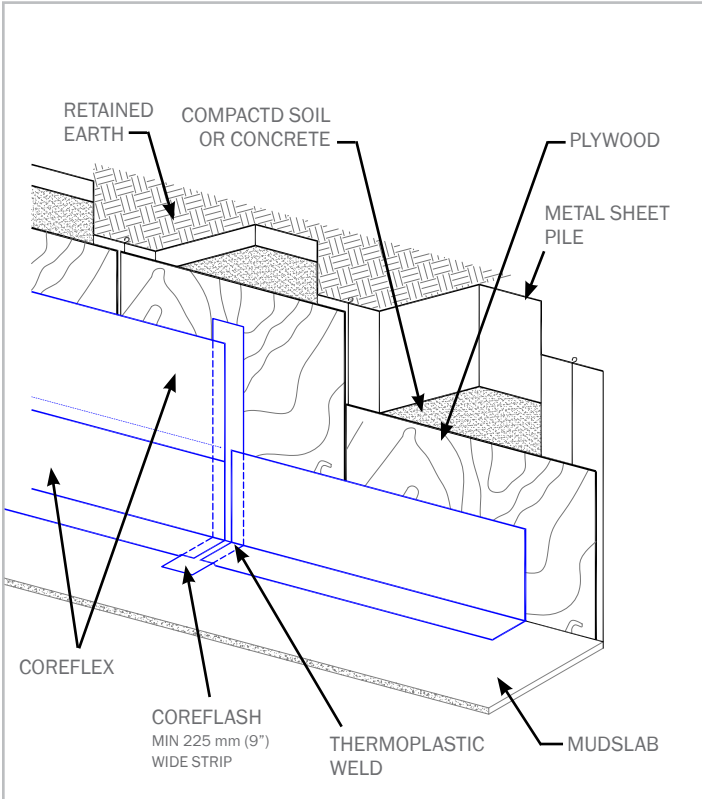

4.2.4 PROPERTY LINE WALL - SHEET PILE

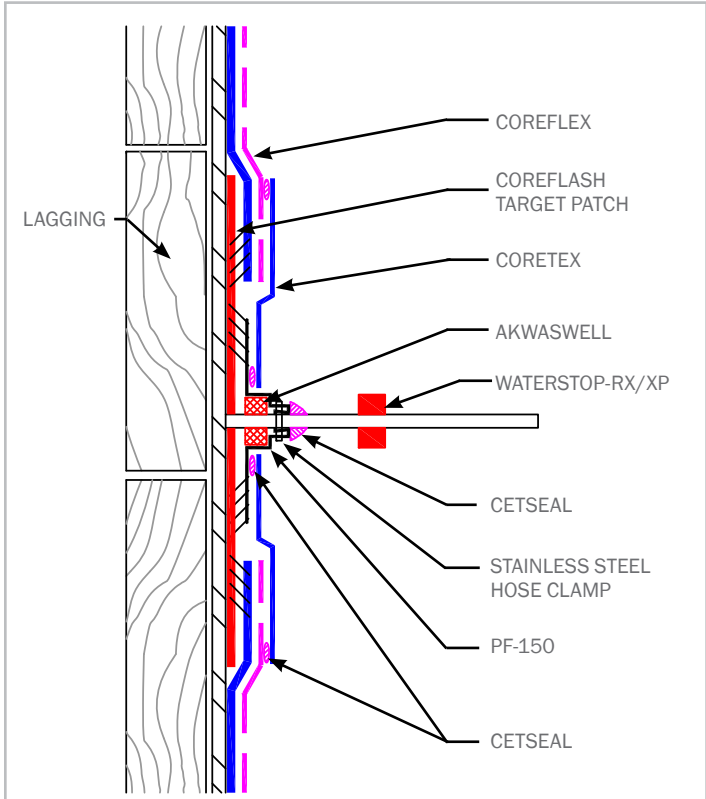

4.2.4 PROPERTY LINE WALL - NELSON STUD FLASHING

COREFLEX®

THERMOPLASTIC WATERPROOFING WITH AN ACTIVE LAYER

4.2.4 AUGER CAST CAISSON AND CUT ROCK EXCAVATION SHORING WALLS

The surface of auger cast caisson and cut rock excavation walls must be sufficiently planar to provide a proper substrate surface to apply COREFLEX. Auger cast caisson and cut rock excavation walls typically require shotcrete or grout work to provide planar surface to install COREFLEX. COREFLEX can be applied over large, relatively shallow indentations in plane where it can conform tight against the surface. The surface should not contain sharp surface depressions or protrusions in excess of 25 mm (1"). Fill all large recesses between caissons or cut rock with cementitious grout or shotcrete prior to installing COREFLEX.

An alternative substrate correction method is to construct a planar substrate surface such as a plywood wall erected over irregular caisson or cut rock walls. Any erected walls shall be approved by project engineer and meet all safety and building code requirements. Any void space between the erected substrate wall and the caisson or cut rock excavation wall shall be completely filled with compacted backfill, concrete, or engineered fill per project requirements.

Employ construction methods to stop water from flowing through the shoring wall prior to waterproofing installation. If only water seepage, install thin polyethylene sheeting over the seepage area prior to installing COREFLEX. Polyethylene sheeting should extend from seepage elevation to base of wall to protect entire waterproofing installation at that area.

4.3 PROPERTY LINE WALL INSTALLATION

At base of the shoring wall, install a COREFLEX corner transition sheet horizontally oriented and placed at the corner transition from under-slab to shoring wall with the PVC thermoplastic membrane offset edge placed on the shoring wall (active layer inward, facing installer; yellow side toward shoring wall), or install in place corner transition with COREFLASH and Coretex. Position the bottom PVC membrane edge extending out onto the horizontal substrate a minimum 300 mm (12"). Approximately 25 mm (1") down from the top edge, secure the thermoplastic membrane offset to the shoring wall with washer-head mechanical fasteners spaced a maximum of 900 mm (36") on center; refrain from placing a fastener within 150 mm (6") of each roll end. Install adjacent membrane sheets with both the thermoplastic membrane and active layers overlapped a minimum 100 mm (4"). Assemble and weld laps, secure any loose active layer material with dabs of CETSEAL maximum 200 mm (8") on center or a continuous bead of CETSEAL. When welding the PVC overlap seams on the corner transition sheet start the weld at the corner and work outward from the corner along both seams. Any T-Joints created require a welded CoreDisc or CoreFlash NR patch.

Once the corner transition sheet has been installed, COREFLEX sheets can be installed either vertically or horizontally oriented on the wall. Fasten the COREFLEX into position with washer-head fasteners maximum 900 mm (36") on center; 25 mm (1") from the top of the thermoplastic membrane selvedge edge. Overlap adjacent sheet edges a minimum 100 mm (4"). (Note: Shingle lap seams so that the bottom edge of the upper sheet is over and inward of the top fastened edge

of the lower sheet to facilitate welding that results with all fasteners positioned outside of the welds). Continue installation up wall until 300 mm (12") below finished grade elevation. Terminate at grade detail as described in section 2.6 to complete the waterproofing membrane installation. This may require the removal of soldier piles and lagging after the concrete wall is poured, see section 4.2.1 or instructions for installing cementitious board, and grade termination detail installation instructions.

Apply COREFLEX membrane in standard roll size or longest workable cut length. Install COREFLEX sheets horizontally oriented with the thermoplastic membrane offset edge side up (active layer side inward facing installer; yellow side toward shoring wall). Approximately 25 mm (1") down from the top edge, secure the thermoplastic membrane offset to the shoring wall with washer-head mechanical fasteners spaced maximum 900 mm (36") on center; refrain from placing a fastener within 150 mm (6") of each roll end. Install subsequent COREFLEX sheets in vertical sequence up wall with membrane roll ends matched to within 25 mm (1"); trim roll ends as applicable to meet the 25 mm (1") alignment. Assemble and weld membrane overlap; secure any loose active layer material with bead of CETSEAL. Extend membrane installation minimum 300 mm (12") above concrete pour joints to provide access.

Alternately, install COREFLEX sheets vertically oriented (active layer side inward facing installer; yellow side toward shoring wall). Approximately 25 mm (1") from the edge, secure the thermoplastic membrane offset to the shoring wall with washer-head mechanical fasteners spaced maximum 900 mm (36") on center; refrain from placing a fastener within 150 mm (6") of each roll end. Install subsequent COREFLEX sheets in vertical sequence along wall. Trim roll ends as applicable to meet the 100 mm (4") overlap onto the membrane selvedge edge of the horizontal transition sheet. Assemble and weld membrane overlaps; secure any loose active layer material with dabs of CETSEAL maximum of 200 mm (8") on center or a continuous bead of CETSEAL. Extend membrane installation minimum 300 mm (12") above concrete pour joints to provide access. Detail all T-Joints with a CoreDisc or CoreFlash NR welded patch. Secure any loose or peeled active layer material with continuous bead of CETSEAL. Continue membrane installation up shoring wall to project grade detail elevation. Secure top membrane edge with washer-head mechanical fasteners maximum 300 mm (12") on center.

Inside and outside corner transitions can also be constructed using CoreFlash and Coretex rather than installing COREFLEX membrane through these changes in plane. Cut and install CoreFlash extending on both substrates of the corner a minimum 300 mm (12"); maintain a minimum 100 mm (4") overlap of all adjacent PVC membrane sheets for proper welded seam. After welding all PVC seams install a cut sheet of Coretex that covers all the installed CoreFlash in the corner and extends a minimum 100 mm (4") overlapping the active layer of all adjacent COREFLEX sheet. Adhere the cut Coretex sheet to both the CoreFlash and the adjacent active layers with continuous beads of CETSEAL placed throughout the area of installation to tightly secure the Coretex.

4.4 REBAR SUPPORTS

CETCO recommends non-penetrating reinforcement systems. When that is not possible use the TW-ANCHOR with weldable flange to support the rebar on concrete/shotcrete shoring walls or on sheet pile with a plywood facing that is backfilled with lean-mix concrete. The TW-ANCHOR can be installed prior to placement of the COREFLEX membrane. The TW-ANCHOR must be installed in sound substrates. Installation requires the drilling of a 28 mm (1 1/8") diameter by 225 mm (9") deep hole, appropriate clean out measures, and epoxying into place. Field verification with the site specific substrate is necessary to determine maximum allowable loads per each unique site condition. Drill a 28 mm (1-1/8") diameter by 225 mm (9") deep hole into the substrate. Care should be taken during the drilling process to eliminate lateral movement of the drill bit, as this will create an oversized hole which can reduce the pull-out load capacity of the installed TW-ANCHOR. Clean out the hole with a long reach air gun to blow debris out of, and away from, the hole. Brush the inside of the hole with 32 mm (1-1/4") stiff bristled pipe brush. After brushing in the hole, repeat blowing out debris with air gun a second time. Repeat this process, as needed, until all dust and debris has been removed from the hole. Starting at the bottom/back of the hole, fill 125 mm (5") of the hole with CETCO approved epoxy. Insert the TW-ANCHOR; twist the anchor into place rather than pushing straight into the hole; back pressure can prevent full insertion if air gets trapped behind the threads. Twisting the TW-ANCHOR during installation also promotes full epoxy coverage around the TW-ANCHOR and hole perimeter. The TW-ANCHOR MUST BE FULLY EMBEDDED; back surface of the rigid flange must be flush against substrate.

Secure the TW-ANCHOR in place until epoxy reaches its initial set. Once the TW-ANCHOR is in place allow for the epoxy to set for the recommended cure time (typically 24 hours, consult epoxy manufacturer if hot, cold or wet conditions exist as this will affect cure time). Thread allthread rod (M16 x 20) into the rigid PVC sleeve until full threaded depth of 196 mm (7 3/4") is achieved. Install COREFLEX waterproofing membrane by cutting around the rigid PVC sleeve base; take care to not cut the flexible TW-ANCHOR membrane flange. With a hot-air hand welder and a 20 mm (3/4") tip, weld the COREFLEX membrane (yellow thermoplastic side) to the TW-ANCHOR flexible membrane flange. Complete the entire weld and test for continuity with a mechanical probing device (blunt tip screwdriver or similar). Cut a round 500 mm (20") patch of Coretex with a 16 mm (5/8") hole in the center and place over the all-thread rod. Use dabs of CETSEAL maximum of 200 mm (8") on center or a continuous bead of CETSEAL adhere the Coretex in place.

4.5 TIE-BACKS

Select the appropriate size TB-Boot and CoreCap weldable thermoplastic flange to fit over tieback plate and allow proper concrete coverage per project requirements. The TB-Boot is a rigid backing piece (white) and the CoreCap is a flexible, weldable PVC component (black). TB-Boot should fit entirely over tie-back head without the tie-back plate or cables in direct contact with the TB-Boot. Prior to TB-Boot installation, fill voids in retention wall substrate and tie-back head assembly

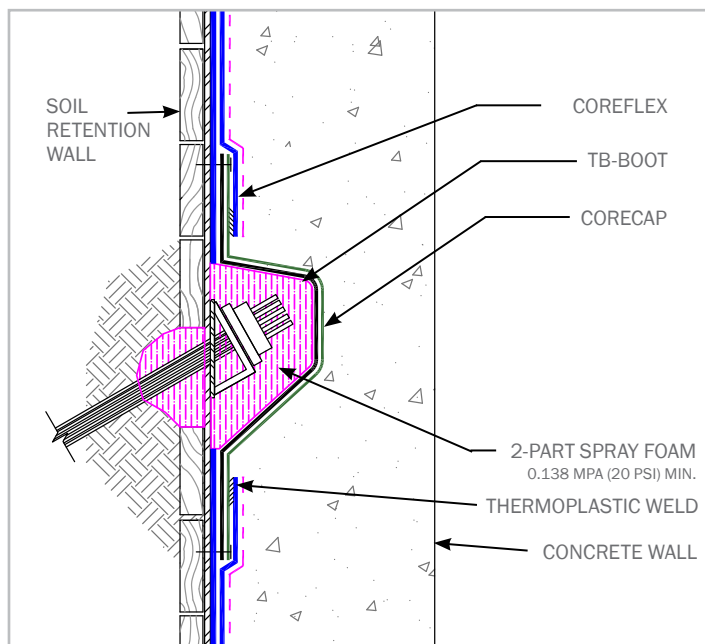

4.5 TIE-BACK BOOT

with spray foam, 0.138 MPa (20 psi) minimum or non-shrink grout. Fill pre-formed shape of the rigid TB Boot with 2-part urethane foam 0.138 MPa (20 psi) minimum and place over the tie-back head before foam sets up. Overlay the CoreCap weldable PVC component over the TB-Boot. With the CoreCap PVC component nested over the TB-Boot, secure both components to the soil retention wall using washer head fasteners along the outside edge of the flat flange base. Begin by placing two fasteners at the top two corners. Then fasten the two bottom corners and follow up by placing a fastener at each midpoint of the 4 edges. All fasteners should be placed a within 75 mm (3") of the TB-BOOT perimeter edge. Once the TB Boot and CoreCap are secured to the soil retention wall cut a window in COREFLEX membrane so that it overlaps the CoreCap weldable flange 100 mm (4") on all four sides. Weld the COREFLEX to the CoreCap on the flat flange with a continuous thermoplastic weld around the tie-back head; all fasteners shall be located outside of the weld. Weld should be verified for continuity to ensure a complete continuous weld. For soil nail rod and plate assemblies, install applicable TB-Boot & CoreCap (typically the TB-Boot 6SN & CoreCap 6) over assembly and fasten to shoring wall and install COREFLEX per TB-Boot & CoreCap installation guidelines herein.

NOTE:

For irregular or oversize tie-back heads, site specific field fabricated stainless steel CoreClad covers may be required in lieu of TB-BOOTS and CORECAPS. CoreClad field fabricated covers per project design will need to be used over large tie-back heads and where irregular (non-planar) shoring wall conditions exist. Consult CETCO for alternate detail for specific project condition(s).

COREFLEX®

THERMOPLASTIC WATERPROOFING WITH AN ACTIVE LAYER

SECTION 5 BACKFILLED WALLS

5.1 SURFACE PREPARATION

The wall surface must be properly prepared before COREFLEX is installed. Cast-in-place concrete to receive waterproofing shall be of sound structural grade with a smooth finish, free of debris, oil, grease, laitance, dirt, dust, or other foreign matter which will impair the performance of the waterproofing. Form fins, ridges, and other protrusions over 6 mm (1/4") shall be made level and smooth with concrete surface. Honeycombing, aggregate pockets, tie-rod holes and other voids shall be completely filled with non-shrink cementitious grout and level with concrete surface. Concrete work should include completely filling taper-tie holes with non-shrink cementitious grout and a piece of WATERSTOP-RX/XP centered in the wall. Apply CETSEAL or Bentoseal over exterior grouted surface of all form tie holes.

Footings should be swept clean of dirt, rocks and debris to provide COREFLEX with direct contact to the concrete.

5.2 INSTALLATION

5.2.1 FOOTING TO WALL CORNER TRANSITION

At the wall/footing intersection, install continuous line of SEAL-X XP cant prior to the placement of the COREFLEX membrane. At any vertical inside corners, apply a 19 mm (3/4") cant of SEAL-X XP prior to the placement of the COREFLEX membrane. Apply COREFLEX membrane in standard roll size or longest workable cut length. Install membrane in a flat, relaxed position avoiding wrinkles and stretching. Install bottom course of COREFLEX membrane horizontally oriented (active layer side against concrete; yellow side facing installer); with the active layer selvedge edge at the top and with the bottom edge extending out onto the footing minimum 200 mm (8") or further as required to overlap leading edge of COREFLEX membrane previously installed under the footing as part of underslab work a minimum 100 mm (4") or to allow for membrane termination detail. Approximately 25 mm (1") down from the top edge of the yellow thermoplastic membrane mechanically attach membrane to the concrete wall with washer-head fasteners spaced maximum 900 mm (36") on center; refrain from placing a fastener within 150 mm (6") of each roll end. 75 mm – 100 mm (3" – 4") intermittent dabs of CETSEAL may be used to adhere the 150 mm (6") active layer selvedge edge to the concrete. Install subsequent COREFLEX sheets in horizontal orientation sequenced up wall with membrane roll ends matched to within 25 mm (1"); trim roll ends as applicable to meet the 25 mm (1") alignment. Assemble and weld membrane overlaps and secure any loose active layer material with bead of CETSEAL.

ALTERNATE MEMBRANE INSTALLATION:

Install COREFLEX membrane sheets vertically oriented. Approximately 25 mm (1") from the edge, secure the thermoplastic membrane offset to the concrete wall with washer-head mechanical fasteners spaced

maximum 900 mm (36") on center; refrain from placing a fastener within 150 mm (6") of each roll end. Install subsequent COREFLEX sheets in vertical sequence along wall. Trim roll ends to meet the 100 mm (4") overlap onto the PVC membrane of the horizontal oriented corner transition sheet. As applicable, install a minimum 450 mm (9") wide strip of Coretex extending a minimum 100 mm (4") over the active layer on the horizontal corner transition sheet active layer selvedge edge and behind the trimmed vertical courses of COREFLEX on the wall. Install adjacent COREFLEX membrane sheets overlapping Coretex strip with rolls ends closely matched to 25 mm (1") of adjacent COREFLEX roll end. Install minimum 450 mm (9") wide strip of CoreFlash centered over Coretex strip detail (yellow side facing installer). The bottom of the vertically oriented CoreFlash strip should overlap 100 mm (4") the horizontally oriented corner transition sheet and extend 100 mm (4") on the ends of the vertically oriented rolls of COREFLEX that continue up the wall. Hot-air weld the termination strip of CoreFlash to the COREFLEX; both continuous welds must be outside of all fasteners (no exposed fasteners). Finish CoreFlash strip by hot-air welding a CoreDisc or CoreFlash NR patch over all T-Joints. Assemble and weld all COREFLEX overlaps and secure any loose active layer material with bead of CETSEAL. Continue membrane installation up concrete wall to project grade detail elevation.

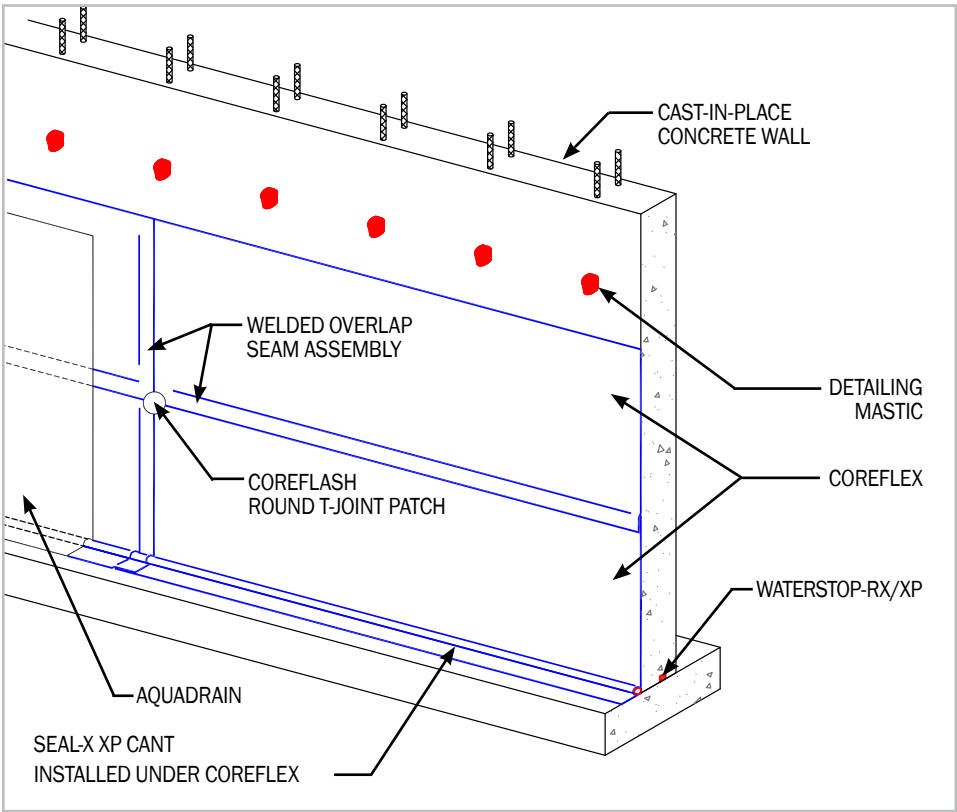

5.2.1 GENERAL INSTALLATION LAYOUT

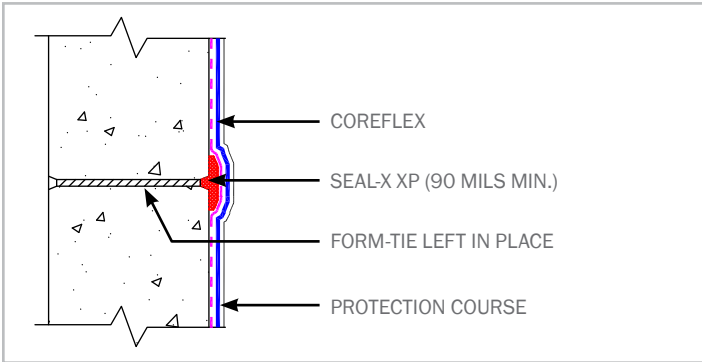

SNAP TIE

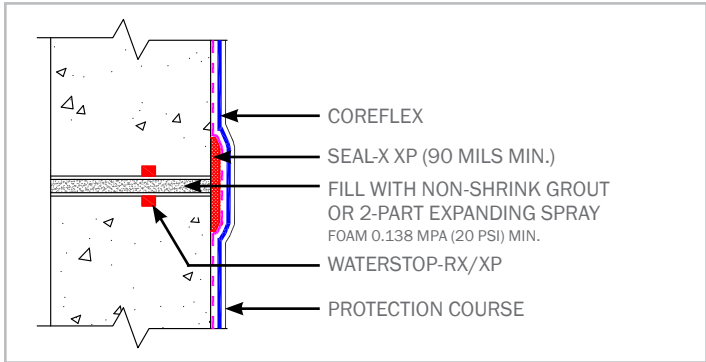

PVC SLEEVE

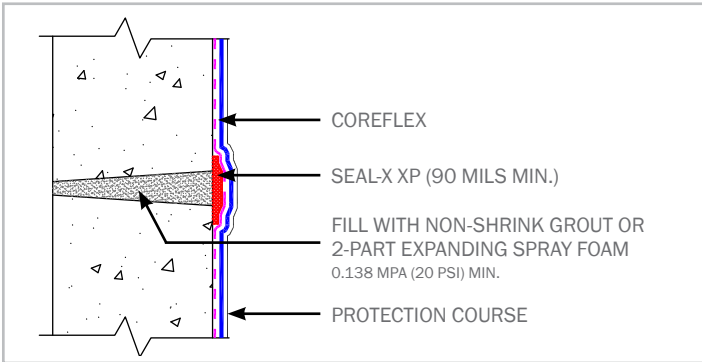

TAPER TIE

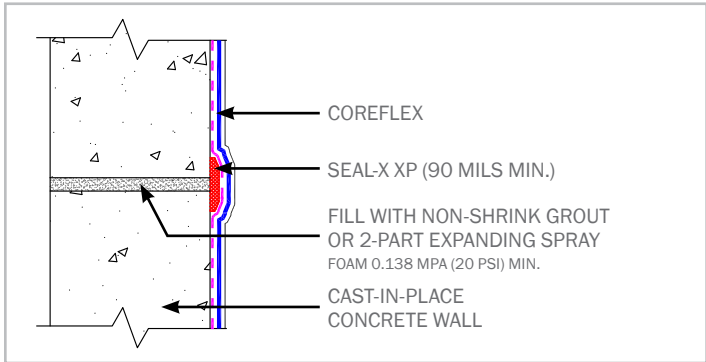

ALL-THREAD ROD

COREFLEX® THERMOPLASTIC WATERPROOFING WITH AN ACTIVE LAYER

5.2.2 GRADE TERMINATIONS

SEE SECTION 2.6 GRADE TERMINATIONS.

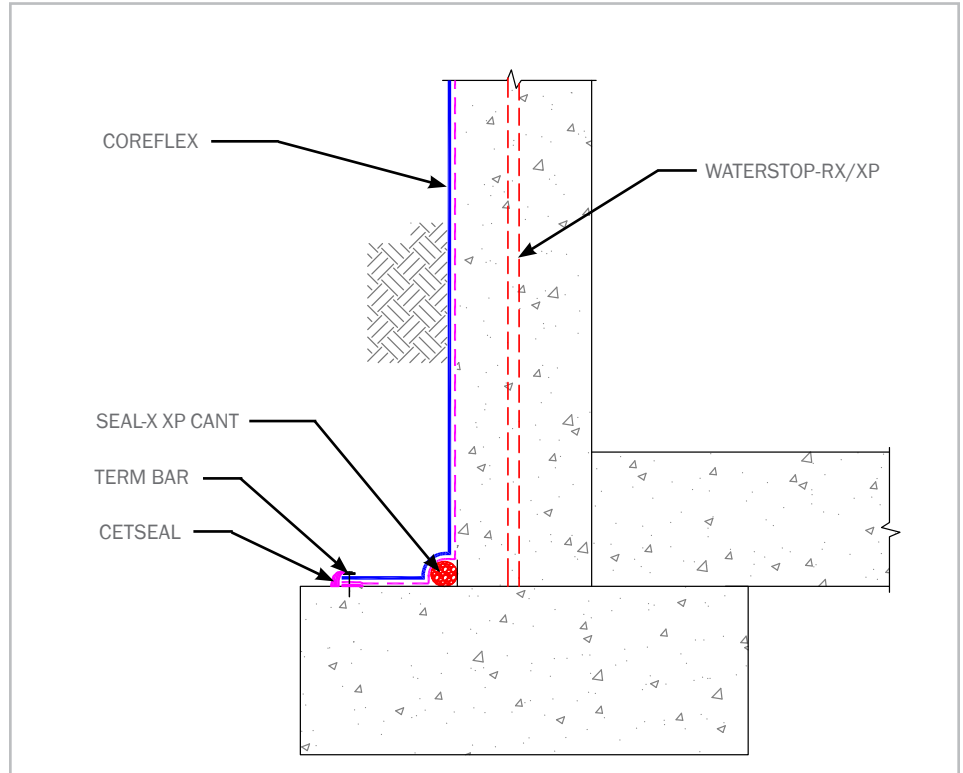

5.2.2 SLAB EDGE TERM AT FOOTER (NON-HYDROSTATIC CONDITION)

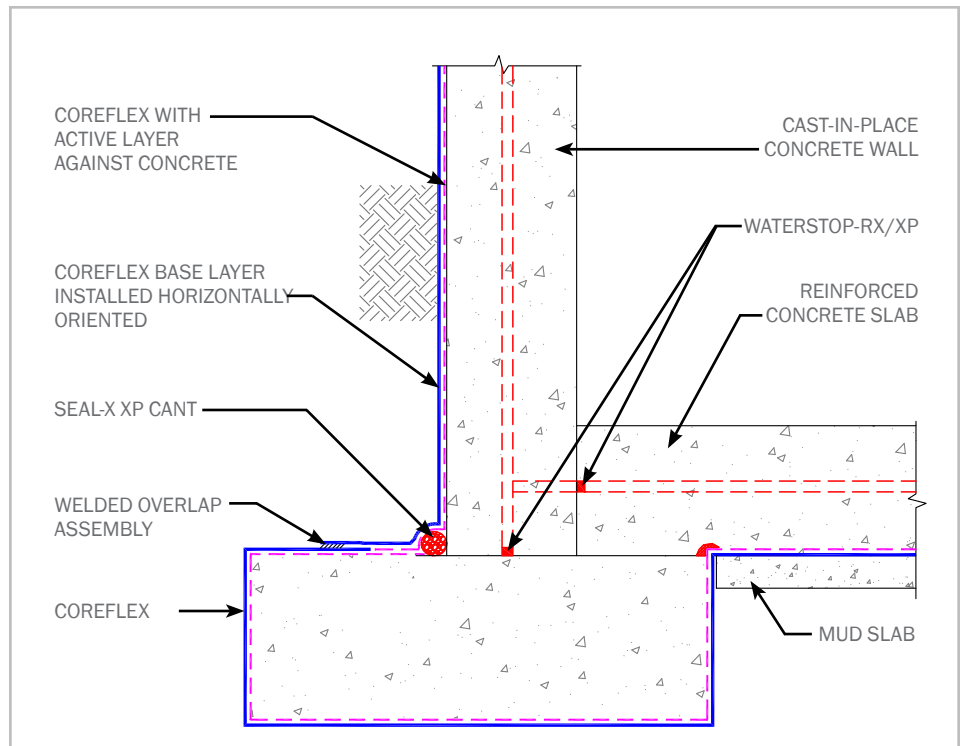

5.2.3 SLAB EDGE (HYDROSTATIC CONDITION)

SECTION 6 SPECIAL CONDITIONS

6.1 PRECAST CONCRETE CONSTRUCTION

Consult CETCO regarding recommended products and special installation guidelines for precast concrete plank decks, precast earth covered roofs, and precast wall construction.

6.2 CONTAMINATED CONDITIONS

For compatibility testing, provide two (2) liter sample of site ground-water in a clean, unbreakable container. Ship water sample to: CETCO 2870 Forbs Avenue, Hoffman Estates, IL 60192, ATTN: BMG Field Services. Upon analysis, CETCO will provide a written report evaluating the water's compatibility with COREFLEX.

6.3 HYDROSTATIC/ NON-HYDROSTATIC CONDITIONS

Hydrostatic conditions exist when the elevation of the below-grade foundation is lower than the project site ground water level or historical high water table. Hydrostatic conditions are typically continual but may be intermittent with the fluctuation of the natural ground water table.

Non-hydrostatic conditions exist when site soil testing has determined that no ground water table exists or the elevation of the below-grade foundation is above the expected historical high water table elevation. Intermediate temporary hydrostatic pressure conditions may exist after precipitation or irrigation but is not a continual or prolonged condition.

6.4 EXPANSION JOINTS

COREFLEX membrane is not designed for waterproof expansion joints. Consult with CETCO regarding all expansion joint applications and limitations.

6.5 MISCELLANEOUS

Use CoreFIASH UV where membrane will be exposed to prolonged direct sunlight at grade terminations. Plywood or cementitious wall board may be used to provide a flat surface mount for installation of the COREFLEX membrane. For underslab or on property line shoring walls, install COREFLEX so that the active layer side is in direct contact with the concrete to be waterproofed. Use WATERSTOP-RX/XP at all (horizontal and vertical) cold concrete joints.

6.6 IMPORTANT NOTICE

FOR PRECAST CONCRETE, AND OTHER APPLICATIONS NOT COVERED IN THIS MANUAL, CONTACT CETCO FOR TECHNICAL ASSISTANCE AND INSTALLATION GUIDELINES.



www.cetco.com | contact@cetco.com

UPDATED: SEPTEMBER 2015

© 2018 Minerals Technologies Inc. IMPORTANT: The information contained herein supersedes all previous printed versions, and is believed to be accurate and reliable. For the most up-to-date information, please visit www.cetco.com. CETCO accepts no responsibility for the results obtained through application of this product. CETCO reserves the right to update information without notice.



FORM: PM_COREFLEX_AM_EN_201509_V2